

VACON[®] 20 CP/X
AC DRIVES

**MULTIPURPOSE APPLICATION
MANUAL**

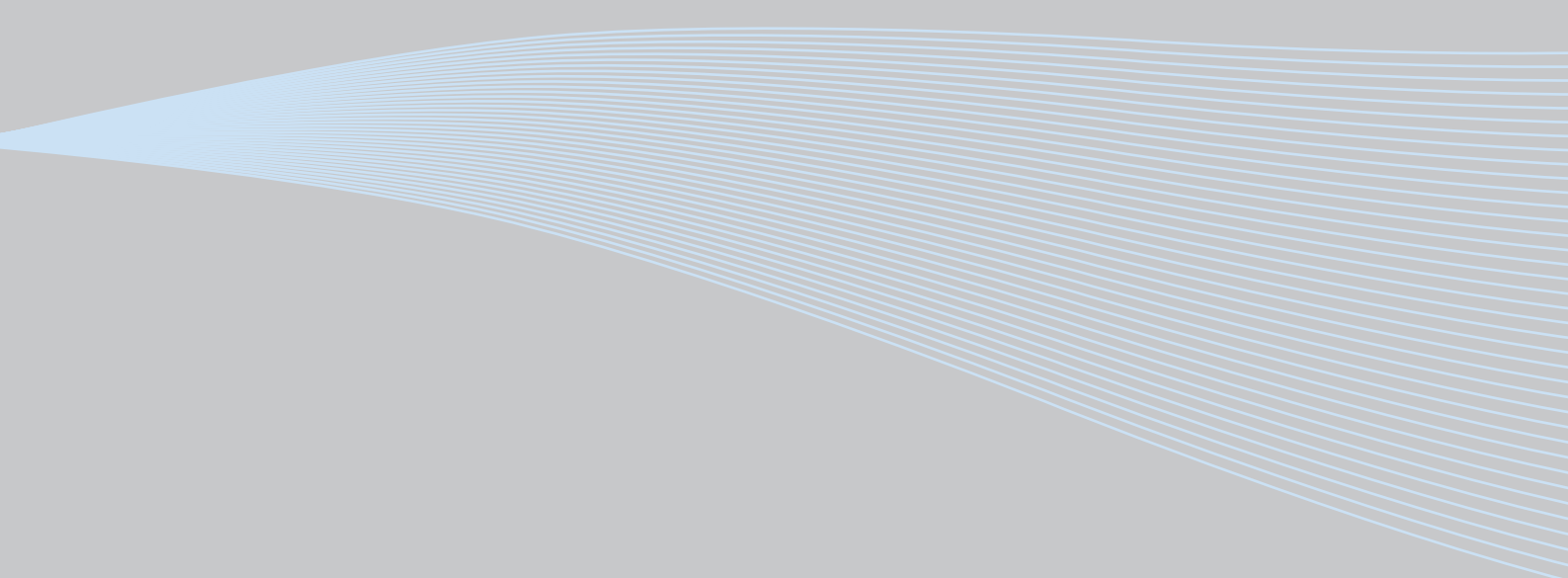

INDEX

Document ID: DPD00536F
 Order code: DOC-APP03982+DLUK
 Rev. F
 Version release date: 26.7.13
 Corresponds to application package ACIT1075V109.vcx

1.	Multipurpose Application.....	2
1.1	Specific functions of Vacon Multipurpose application.....	2
1.2	Example of control connections	3
1.3	Optional boards	5
1.3.1	Option board installation.....	7
2.	Description of Groups	12
2.1	Keypad Reference: Menu REF	12
2.2	Monitor group: menu MON	13
2.3	Parameter Groups: Menu PAR	14
2.3.1	Group Basic Parameters: Menu PAR G1	15
2.3.2	Group Advanced Settings: Menu PAR G2.....	16
2.3.3	Group Analogue inputs: Menu PAR G3	18
2.3.4	Group Digital inputs: Menu PAR G4	19
2.3.5	Group Digital outputs: Menu PAR G5.....	20
2.3.6	Group Analogue outputs: Menu PAR G6	21
2.3.7	Group Supervisions: Menu PAR G7.....	22
2.3.8	Group Motor Control: Menu PAR G8.....	23
2.3.9	Group Protections: Menu PAR G9.....	25
2.3.10	Group Automatic reset: Menu PAR G10.....	27
2.3.11	Group Fieldbus: Menu PAR G11	28
2.3.12	Group PID-controller: Menu Par G12	29
2.3.13	Group temperature measurement: Menu Par G13	30
2.4	System parameters, Faults and History faults: Menu FLT	31
3.	Parameter description.....	34
3.1	Basic Parameters.....	34
3.2	Advanced settings	35
3.3	Analogue inputs.....	43
3.4	Digital inputs	47
3.5	Digital outputs	49
3.6	Analogue Output.....	51
3.7	Supervisions	52
3.8	Motor control.....	53
3.9	Protections	57
3.10	Automatic reset.....	63
3.11	Fieldbus	64
3.11.1	Fieldbus mapping.....	65
3.12	PID-controller	68
3.13	Temperature measurement	70
4.	Fault tracing	72

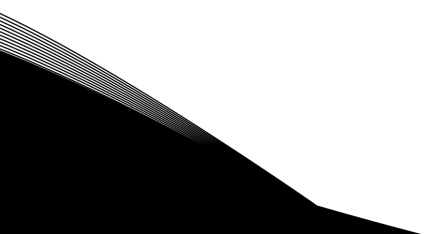

1. MULTIPURPOSE APPLICATION

The VACON® 20 CP/X drive contains a preloaded application for instant use.

The parameters of this application are listed in chapter 2.3 of this manual and explained in more detail in chapter 2.

1.1 SPECIFIC FUNCTIONS OF VACON MULTIPURPOSE APPLICATION

The Vacon Multipurpose allows flexible use of VACON® 20 CP/X frequency converters.

Features

The drive can be controlled through I/O terminals, a fieldbus or the optional keypad. Two programmable control places and sources for the frequency reference are available, for easy local/remote control.

Frequency reference can be direct (analogue input, preset speeds, motor potentiometer, fieldbus) or controlled by the internal PID regulator.

PID setpoint and actual value are totally programmable. A "sleep" function is available, with possibility of pressure boost and check of the losses before entering the stand-by state.

All the functionalities can be controlled through a fieldbus.

The motor identification function allows automatic optimization of the voltage/frequency curve, for an optimal torque response also at low motor speed.

It is possible to install one optional board for I/O expansion.

1.2 EXAMPLE OF CONTROL CONNECTIONS

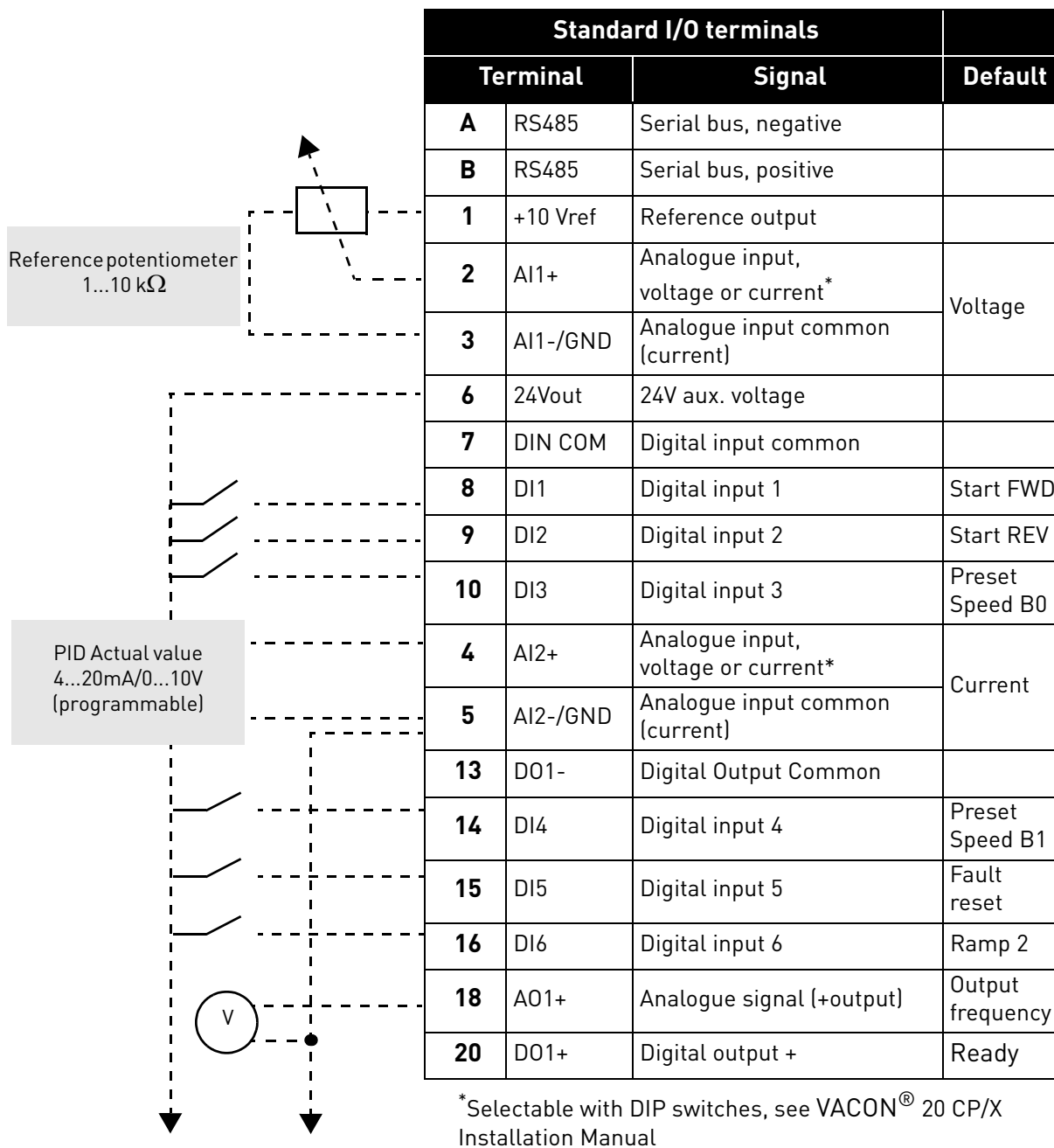

Table 1. Connection example, standard I/O terminals.

To Relay terminals
1 or 2

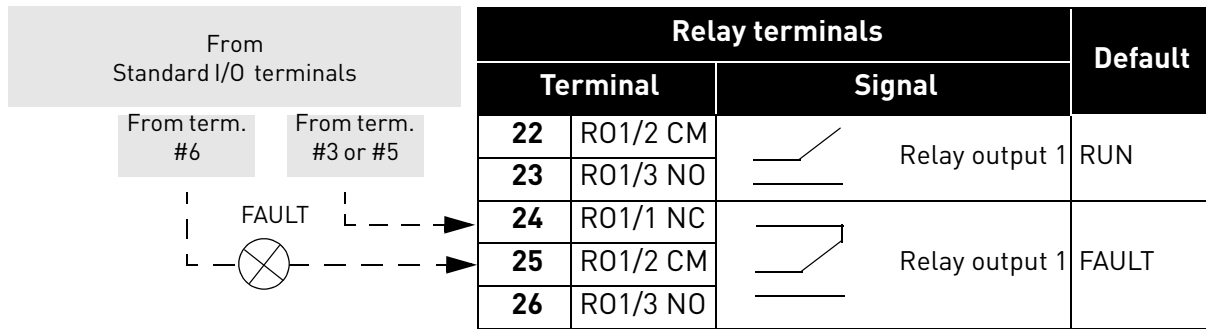

Table 2. Connection example, Relay terminals

1.3 OPTIONAL BOARDS

One optional I/O expansion board can be installed into the slot on the right side of the drive. The following boards are supported:

OPTB1: 6 Digital Inputs-Outputs

The first 3 terminals are reserved as digital inputs (DI7, DI8, DI9). The second 3 terminals can be used as inputs (DI10, DI11, DI12) or digital outputs (E01, E02, E03). The number of terminals used as input must be declared in parameter P2.24 (hidden if the board is not installed). This number determines the higher value for the selection of the digital input connected to a certain logical function. It also changes the visibility of parameters for the selection of digital outputs function (P5.9, P5.10, P5.11).

OPTB2: 1 Thermistor Input, 2 Relays Outputs

Response to thermistor fault can be programmed with parameter P9.16. Relays functions can be programmed with parameters P5.9, P5.10 (hidden if the board is not installed).

OPTB4: 1 Analogue Input, 2 Analogue Outputs

One more input is available as frequency reference. Two more outputs are available to monitor motor/drive signals.

OPTB5: 3 Relays Outputs

Relays functions can be programmed with parameters P5.9, P5.10, P5.11 (hidden if the board is not installed).

OPTB9: 5 Digital Inputs, 1 Relay Output

The higher value for the selection of the digital input connected to a certain logical function is set to 11. Relay functions can be programmed with parameters P5.9 (hidden if the board is not installed).

OPTBF: 1 Analogue Output, 1 Digital Output, 1 Relay Output

The analogue output can be programmed with parameters P5.5 - 8. The digital output can be programmed with parameter P5.12. The digital output can be programmed with parameter P5.9. Parameters are hidden if the board is not installed.

OPTBH: 3 temperature sensors

When the board is installed, the specific menu G13 is visible. Temperature measurement can be used to set a digital/relay output and/or to trigger a fault. It can also be used as direct frequency reference or as actual value for PID regulation.

OPTC3/E3: Profibus DPV1 fieldbus board

Vacon 20CP/X frequency converters can be connected to the PROFIBUS DP network using a fieldbus board. The converter can then be controlled, monitored and programmed from the Host system. OPTC3 option board also supports connection from DP Master (class 2) if DP-V1 is enabled. In this case, the Master class 2 can initiate a connection, read and write parameters using the PROFIdrive Parameter Access service, and close the connection. The PROFIBUS DP fieldbus is connected to the OPTC3 board using a 5-pin pluggable bus connector. The only difference between OPTC3 and OPTC5 boards is the fieldbus connector.

OPTC4 Lonworks fieldbus board

Vacon 20CP/X frequency converters can be connected to the LonWorks® network using a fieldbus board. The converter can then be controlled, monitored and programmed from the Host system.

OPTC5/E5: Profibus DPV1 fieldbus board (D-type connector)

Vacon 20CP/X frequency converters can be connected to the PROFIBUS DP network using a fieldbus board. The converter can then be controlled, monitored and programmed from the Host system. OPTC5 option board also supports connection from DP Master (class 2) if DP-V1

is enabled. In this case, the Master class 2 can initiate a connection, read and write parameters using the PROFIdrive Parameter Access service, and close the connection. The PROFIBUS DP fieldbus is connected to the OPTE5 board using a 9-pin female sub-D-connector. The only difference between OPTE3 and OPTE5 boards is the fieldbus connector.

OPTC6/E6: CanOpen fieldbus board

Vacon 20CP/X frequency converters can be connected to the CanOpen system using a fieldbus board. The converter can then be controlled, monitored and programmed from the Host system. Vacon CanOpen Board is connected to the fieldbus through a 5-pin pluggable bus connector (board NXOPTE6).

OPTC7/E7: DeviceNet fieldbus board

Vacon 20CP/X frequency converters can be connected to the DeviceNet using a fieldbus board. The converter can then be controlled, monitored and programmed from the Host system. Vacon DeviceNet Board is connected to the fieldbus through a 5-pin pluggable bus connector (board OPTE7).

OPTCI: Modbus TCP fieldbus board

Vacon 20CP/X frequency converters can be connected to Ethernet using an Ethernet fieldbus board OPTCI. Every appliance connected to an Ethernet network has two identifiers; a MAC address and an IP address. The MAC address (Address format: xx:xx:xx:xx:xx:xx) is unique to the appliance and cannot be changed. The Ethernet board's MAC address can be found on the sticker attached to the board or by using the Vacon IP tool software NCIPConfig. Please find the software installation at www.vacon.com. In a local network, IP addresses can be defined by the user as long as all units connected to the network are given the same network portion of the address. For more information about IP addresses, contact your Network Administrator. Overlapping IP addresses cause conflicts between appliances.

OPTCP: Profinet fieldbus board

Vacon 20CP/X frequency converters can be connected to Ethernet using an Ethernet fieldbus board OPTCP. Every appliance connected to an Ethernet network has two identifiers; a MAC address and an IP address. The MAC address (Address format: xx:xx:xx:xx:xx:xx) is unique to the appliance and cannot be changed. The Ethernet board's MAC address can be found on the sticker attached to the board or by using the Vacon IP tool software NCIPConfig. You can find the software installation at www.vacon.com. In a local network, IP addresses can be defined by the user as long as all units connected to the network are given the same network portion of the address. For more information about IP addresses, contact your Network Administrator. Overlapping IP addresses cause conflicts between appliances.

OPTCQ: Ethernet IP fieldbus board

Vacon 20CP/X frequency converters can be connected to Ethernet using an EtherNet/IP fieldbus board OPT-CQ. Every appliance connected to an Ethernet network has two identifiers; a MAC address and an IP address. The MAC address (Address format: xx:xx:xx:xx:xx:xx) is unique to the appliance and cannot be changed. The EtherNet/IP board's MAC address can be found on the sticker attached to the board or by using the Vacon IP tool software NCIPConfig. Please find the software installation at www.vacon.com. In a local network, IP addresses can be defined by the user as long as all units connected to the network are given the same network portion of the address. For more information about IP addresses, contact your Network Administrator. Overlapping IP addresses cause conflicts between appliances.

1.3.1 OPTION BOARD INSTALLATION



NOTE! It is not allowed to add or replace option boards or fieldbus boards on an AC drive with the power switched on. This may damage the boards.

1

- Open the cover of the drive.

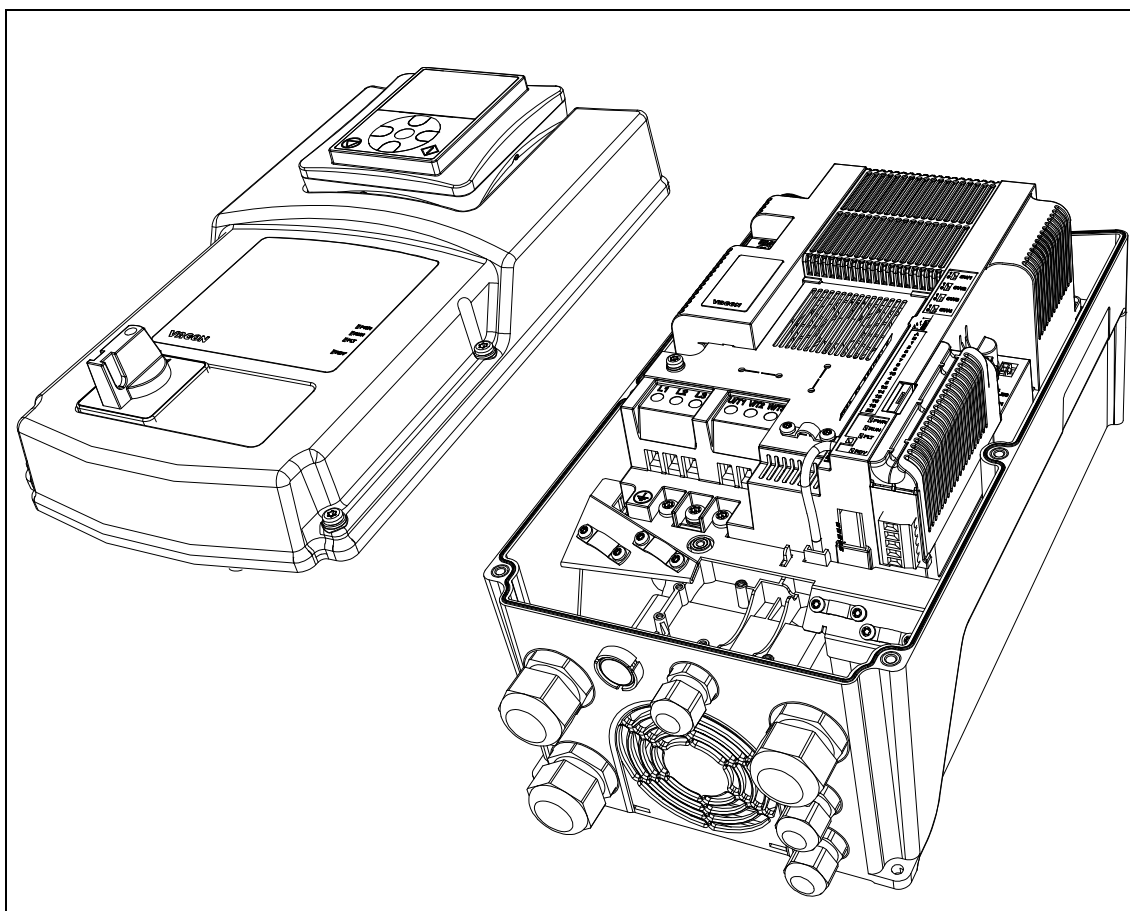

Figure 1. Opening the main cover, MU3 example.



The relay outputs and other I/O-terminals may have a dangerous control voltage present even when the drive is disconnected from mains.

2

- Remove the option slot cover.

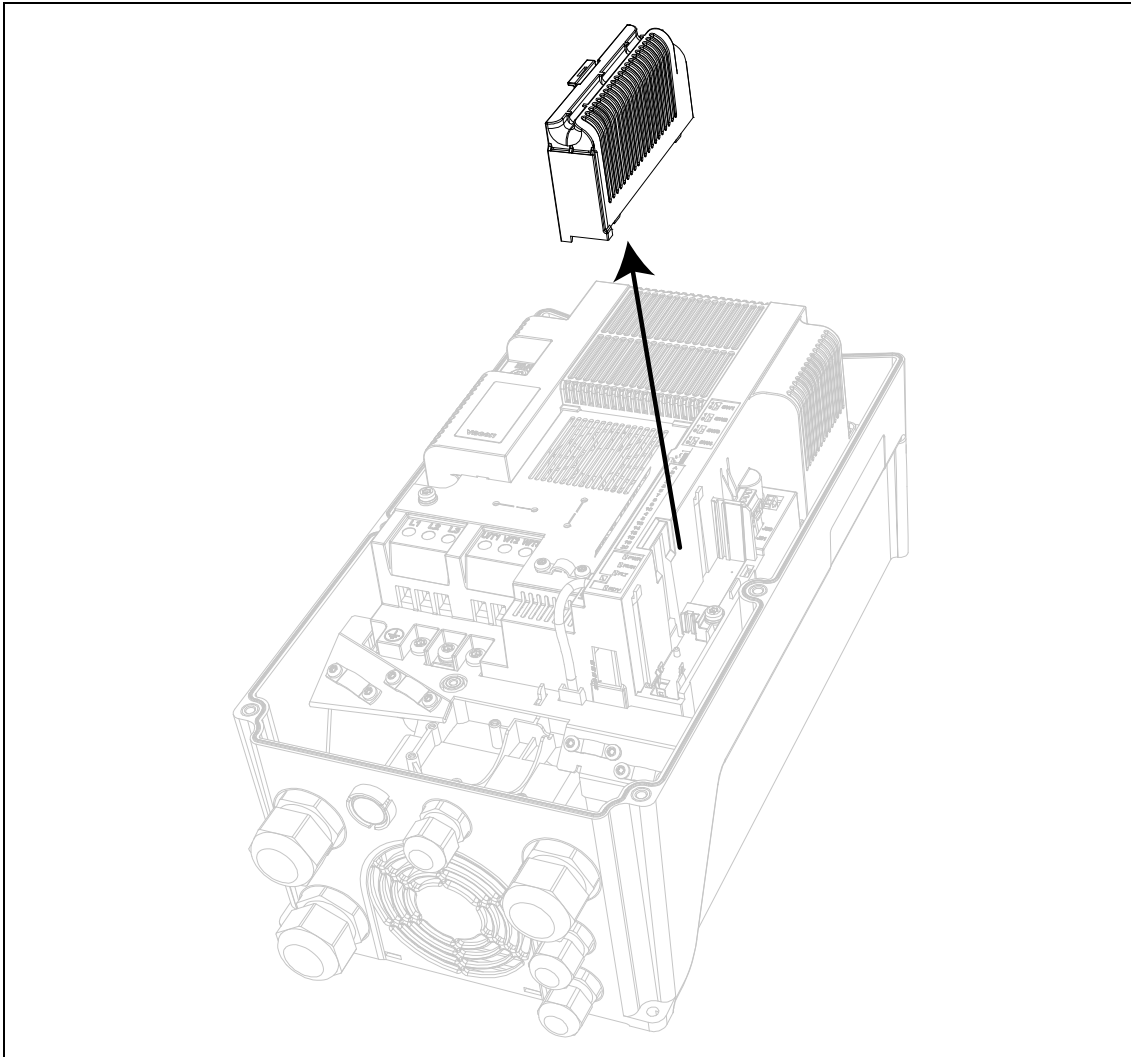

Figure 2. Removing the option slot cover.

3	<ul style="list-style-type: none"> Make sure that the sticker on the connector of the board says "dv" (dual voltage). This indicates that the board is compatible with Vacon 20CP/X. See below: <div style="text-align: center;"> </div> <p style="text-align: right; font-size: small;">9116.emf</p> <ul style="list-style-type: none"> NOTE: Incompatible boards cannot be installed on Vacon 20CP/X. Compatible boards have a slot coding that enable the placing of the board (see above).
---	---

4

- Install the option board into the slot as shown in the picture below.

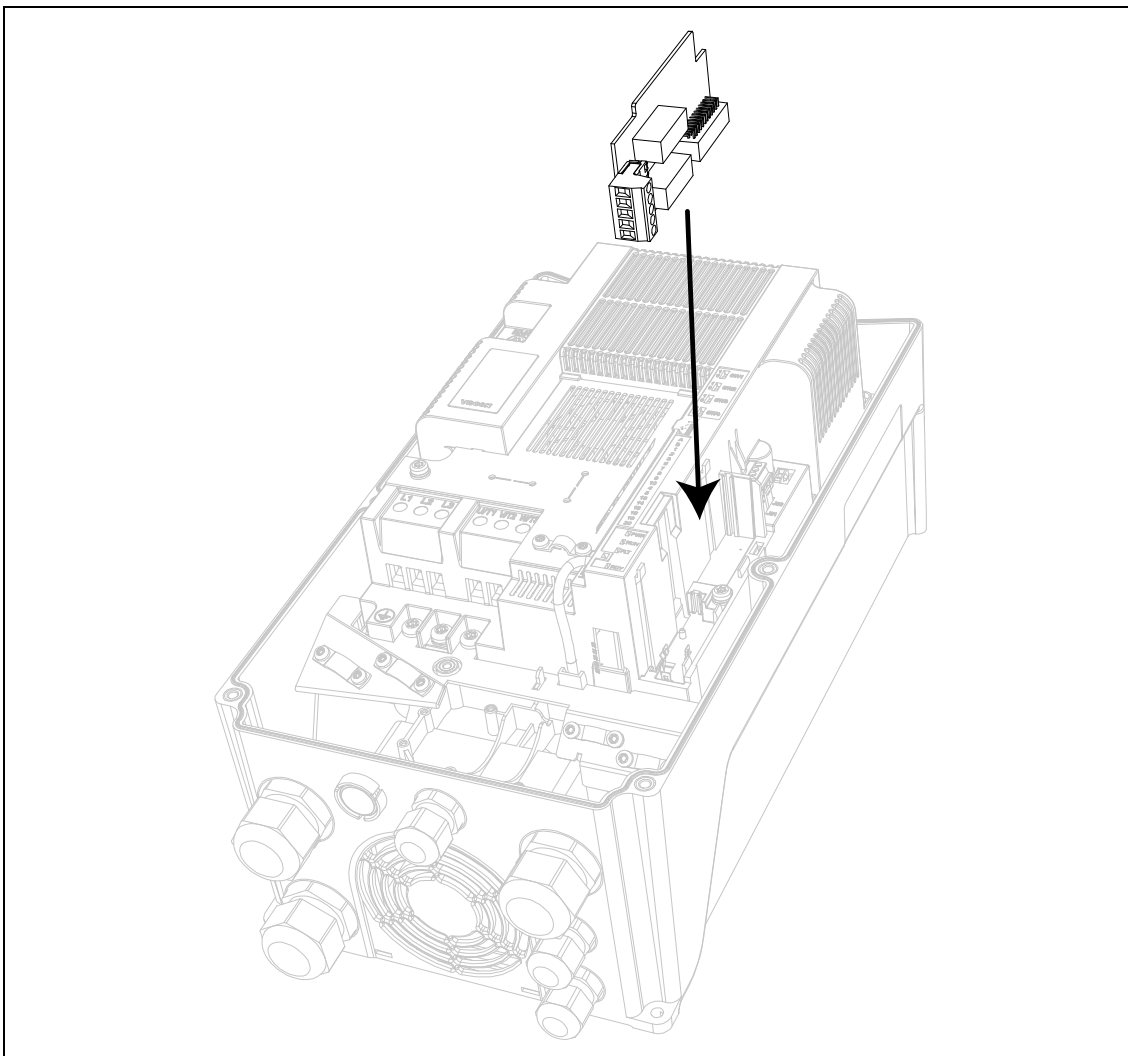

Figure 3. Option board installation.

5

- Mount the option slot cover.

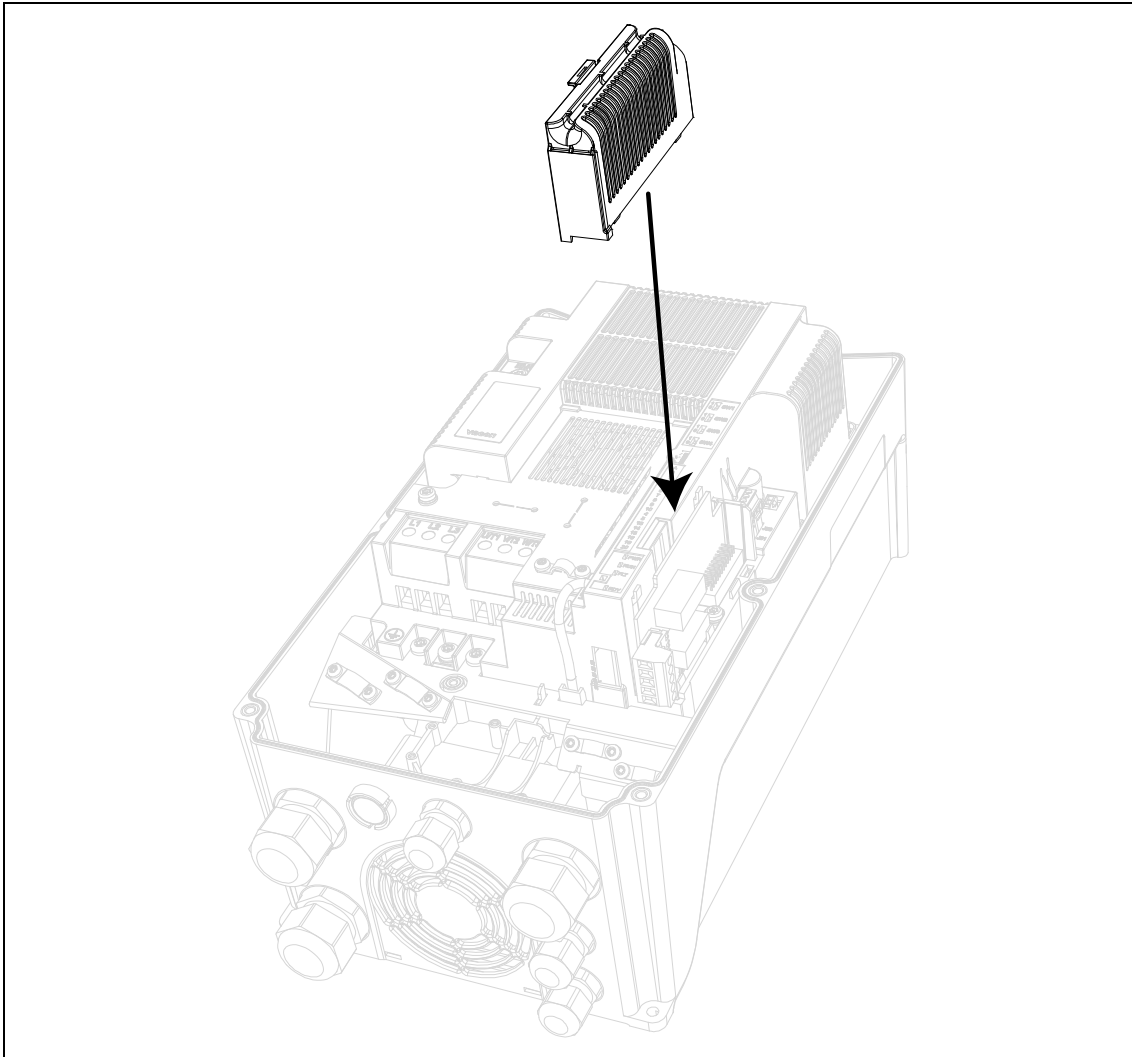

Figure 4. Mounting of option slot cover.

2. DESCRIPTION OF GROUPS

2.1 KEYPAD REFERENCE: MENU REF

This menu is automatically entered when pressing the LOC/REM keypad and shows the frequency reference in Local control mode.

The reference is also active when selected as main reference (P1.12=4) or as secondary reference (P2.15=4).

Value is limited between min frequency P1.1 and max frequency P1.2.

In Local mode, or when keypad is the active control place (P1.11=1 or P2.14=1), direction of rotation is determined with P2.23 or by pressing the left or right arrow button.

2.2 MONITOR GROUP: MENU M0N

VACON® 20 CP/X AC drive provides you with a possibility to monitor the actual values of parameters and signals as well as statuses and measurements. Some of the values to be monitored are adjusted. See Table 3 in which the basic monitoring values are presented.

Code	Monitoring value	Unit	ID	Description
V1.1	Output frequency	Hz	1	Output frequency to motor
V1.2	Frequency reference	Hz	25	Frequency reference to motor control
V1.3	Motor speed	rpm	2	Motor speed in rpm
V1.4	Motor current	A	3	
V1.5	Motor torque	%	4	Calculated shaft torque
V1.6	Motor shaft power	%	5	Total power consumption of AC drive
V1.7	Motor voltage	V	6	
V1.8	Motor temperature	%	9	Calculated motor temperature
V1.9	DC link voltage	V	7	
V1.10	Unit temperature	°C	8	Heatsink temperature
V1.11	Board temperature	°C	1825	Power board temperature
V1.12	Analogue input 1	%	13	Analogue input AI1
V1.13	Analogue input 2	%	14	Analogue input AI2
V1.14	Exp. Analogue input	%	1837	Analogue input on OPTB4
V1.15	Analogue output	%	26	Analogue output
V1.16	Exp. Analogue out 1	%	1838	Analogue output 1 on OPTB4-BF
V1.17	Exp. Analogue out 2	%	1839	Analogue output 2 on OPTB4
V1.18	DI1, DI2, DI3		15	Digital inputs status
V1.19	DI4, DI5, DI6		16	Digital inputs status
V1.20	DI7, DI8, DI9		1835	Digital inputs on OPTB1 status
V1.21	DI10, DI11, DI12		1836	Digital inputs on OPTB1 status
V1.22	RO1, RO2, DO		17	Digital outputs status
V1.23	E01, E02, E03		1852	Expansion board digital outputs status
V1.24	Process variable		29	Scaled process variable See parameter P7.10
V1.25	PID setpoint	%	20	PID controller setpoint
V1.26	PID error value	%	22	PID controller error
V1.27	PID feedback	%	21	PID controller actual value
V1.28	PID output	%	23	PID controller output
V1.29	Temperature sensor 1	°C or °K	1860	OPTBH sensor 1
V1.30	Temperature sensor 2	°C or °K	1861	OPTBH sensor 1
V1.31	Temperature sensor 3	°C or °K	1862	OPTBH sensor 1

Table 3. Monitoring menu items.

NOTE!	<p>Values V1.25-28 are hidden when PID output is not used as frequency reference.</p> <p>Values V1.14, V1.17 are hidden when OPTB4 expansion board is not installed. Value V1.16 is hidden when OPTB4-BF expansion board is not installed. Value V1.20, V1.21 are hidden when no expansion board with available inputs is installed. Value V1.23 is hidden when no expansion board with available outputs is installed. Values V1.29, V1.30, V1.31 are hidden when OPTBH expansion board is not installed.</p>
--------------	--

2.3 PARAMETER GROUPS: MENU PAR

The Multipurpose Application embodies the following parameter groups:

Menu and Parameter group	Description
Group Basic Parameters: Menu PAR G1	Basic settings
Group Advanced Settings: Menu PAR G2	Advanced parameter settings
Group Analogue inputs: Menu PAR G3	Analogue input programming
Group Digital inputs: Menu PAR G4	Digital input programming
Group Digital outputs: Menu PAR G5	Digital output programming
Group Analogue outputs: Menu PAR G6	Analogue outputs programming
Group Supervisions: Menu PAR G7	Prohibit frequencies programming
Group Motor Control: Menu PAR G8	Motor control and U/f parameters
Group Protections: Menu PAR G9	Protections configuration
Group Automatic reset: Menu PAR G10	Auto reset after fault configuration
Group Fieldbus: Menu PAR G11	Fieldbus data out parameters
Group PID-controller: Menu Par G12	Parameters for PID Controller.
Group Temperature measurement: Menu Par G13	Temperature measurement parameters.

Table 4. Parameter groups

Column explanations:

- Code = Location indication on the keypad; Shows the operator the parameter number.
- Parameter= Name of parameter
- Min = Minimum value of parameter
- Max = Maximum value of parameter
- Unit = Unit of parameter value; Given if available
- Default = Value preset by factory
- ID = ID number of the parameter
- Description= Short description of parameter values or its function
-  = The parameter may be changed only in Stop state

2.3.1 GROUP BASIC PARAMETERS: MENU PAR G1

Code	Parameter	Min	Max	Unit	Default	ID	Description
P1.1	Minimum frequency	0.00	P1.2	Hz	0.00	101	Minimum allowed frequency reference
P1.2	Maximum frequency	P1.1	320.00	Hz	50.00	102	Maximum allowed frequency reference
P1.3	Acceleration time 1	0.1	3000.0	s	3.0	103	Defines the time required for the output frequency to increase from zero frequency to maximum frequency
P1.4	Deceleration time 1	0.1	3000.0	s	3.0	104	Defines the time required for the output frequency to decrease from maximum frequency to zero frequency
P1.5	Motor current limit	$0.2 \times I_H$	$2 \times I_H$	A	I_H	107	Maximum motor current from AC drive
P1.6	Motor nominal voltage	180	500	V	400	110	Find this value U_n on the rating plate of the motor. This parameter sets the voltage at the field weakening point to $100\% \times U_{nMotor}$. Note also used connection (Delta/Star).
P1.7	Motor nominal frequency	8.00	320.00	Hz	50.00	111	Find this value f_n on the rating plate of the motor.
P1.8	Motor nominal speed	24	20000	rpm	1440	112	Find this value n_n on the rating plate of the motor.
P1.9	Motor nominal current	$0.2 \times I_H$	$2 \times I_H$	A	I_H	113	Find this value I_n on the rating plate of the motor.
P1.10	Motor Cos Phi	0.30	1.00		0.85	120	Find this value on the rating plate of the motor
P1.11	Control Place Selection	0	2		0	125	Run and direction control: 0 = I/O terminals 1 = Keypad 2 = Fieldbus
P1.12	Frequency reference selection	0	5-7*		0	1819	Selection of reference source: 0 = AI1 1 = AI2 2 = PID reference 3 = Motor potentiometer 4 = Keypad 5 = Fieldbus 6 = Expansion AI1 7 = Temperature [*]6 requires expansion board OPTB4; 7 requires expansion board OPTBH.
P1.13	Start function	0	1		0	505	0=Ramping 1=Flying start
P1.14	Stop function	0	1		0	506	0=Coasting 1=Ramping

P1.15	U/f optimization	0	1		0	109	0 = Not active 1 = Auto torque boost
P1.16	Show Advanced parameters	0	1		0	115	0 = only Basic 1 = All groups

Table 5. Basic parameters.

2.3.2 GROUP ADVANCED SETTINGS: MENU PAR G2

Code	Parameter	Min	Max	Unit	Default	ID	Description
P2.1	Start/Stop logic	0	3		0	300	Logic = 0: Start sgn 1 = Start Forward Start sgn 2 = Start Backward Logic = 1: Start sgn 1 = Start Start sgn 2 = Reverse Logic = 2: Start sgn 1 = Start pulse Start sgn 2 = Stop pulse Logic = 3: Start sgn 1 = Start Forward (edge) Start sgn 2 = Start Backward (edge)
P2.2	Preset frequency 1	0.00	P1.2	Hz	10.00	105	Multistep speed 1
P2.3	Preset frequency 2	0.00	P1.2	Hz	15.00	106	Multistep speed 2
P2.4	Preset frequency 3	0.00	P1.2	Hz	20.00	126	Multistep speed 3
P2.5	Preset frequency 4	0.00	P1.2	Hz	25.00	127	Multistep speed 4
P2.6	Preset frequency 5	0.00	P1.2	Hz	30.00	128	Multistep speed 5
P2.7	Preset frequency 6	0.00	P1.2	Hz	40.00	129	Multistep speed 6
P2.8	Preset frequency 7	0.00	P1.2	Hz	50.00	130	Multistep speed 7
P2.9	Acceleration time 2	0.1	3000.0	s	10.0	502	Time from 0 to max frequency
P2.10	Deceleration time 2	0.1	3000.0	s	10.0	503	Time from 0 to max frequency
P2.11	Acceleration time 2 freq. threshold	0.00	P1.2	Hz	0.00	527	Threshold for auto change from acc1 to acc2
P2.12	Deceleration time 2 freq. threshold	0.00	P1.2	Hz	0.00	528	Threshold for auto change from dec2 to dec1
P2.13	Ramp shape	0.0	10.0	s	0.0	500	Rounded speed profile.
P2.14	Control place 2 selection	0	2		0	1806	Alternative control place: 0: I/O terminals 1: Keypad 2: Fieldbus

P2.15	Frequency reference 2 selection	0	5-7*		1	1820	Selection of reference source 2: 0 = AI1 1 = AI2 2 = PID reference 3 = Motor potentiometer 4 = Keypad 5 = Fieldbus 6 = Expansion AI1 7 = Temperature {*}6 requires expansion board OPTB4; 7 requires expansion board OPTBH.
P2.16	Motor potentiometer ramp time	1	50	Hz/s	5	331	Rate of change in the motor potentiometer reference when increased or decreased.
P2.17	Motor potentiometer reset	0	2		0	367	Motor potentiometer frequency reference reset logic. 0 = No reset 1 = Reset if stopped or powered down 2 = Reset if powered down
P2.18	Skip frequency range 1 low limit	0.00	P1.2	Hz	0.00	509	0 = Not used
P2.19	Skip frequency range 1 high limit	0.00	P1.2	Hz	0.00	510	0 = Not used
P2.20	Skip frequency range 2 low limit	0.00	P1.2	Hz	0.00	511	0 = Not used
P2.21	Skip frequency range 2 high limit	0.00	P1.2	Hz	0.00	512	0 = Not used
P2.22	Keypad stop button	0	1		1	114	0 = Limited function of Stop button 1 = Stop button always enabled
P2.23	Keypad direction	0	1		0	123	Motor rotation when control place is keypad 0 = Forward 1 = Reverse
P2.24	OPTB1 Digital inputs	3	6		6	1829	Number of terminals used as digital inputs. The parameter is visible only when OPTB1 board is installed
P2.25	Quick Stop dec. time	0.1	3000.0	s	2.0	1889	Time from max frequency to 0

Table 6. Advanced settings group.

NOTE!	Visibility of the group depends on P1.16.
--------------	---

2.3.3 GROUP ANALOGUE INPUTS: MENU PAR G3

Code	Parameter	Min	Max	Unit	Default	ID	Description
P3.1	AI1 signal range	0	1		0	379	0 = 0...10V / 0...20mA 1 = 2...10V / 4...20mA
P3.2	AI1 custom. min	-100.00	100.00	%	0.00	380	Custom range min setting 20% = 4-20 mA/2-10 V
P3.3	AI1 custom. max	-100.00	300.00	%	100.00	381	Custom range max setting
P3.4	AI1 signal filter time	0.0	10.0	s	0.1	378	Filter time for analogue input
P3.5	AI2 signal range	0	1		1	390	0 = 0...10V / 0...20mA 1 = 2...10V / 4...20mA
P3.6	AI2 custom. min	-100.00	100.00	%	0.00	391	See P3.2
P3.7	AI2 custom. max	-100.00	300.00	%	100.00	392	See P3.3
P3.8	AI2 signal filter time	0.0	10.0	s	0.1	389	See P3.4
P3.9	Exp. AI signal range	0	1		0	1841	0 = 0...10V / 0...20mA 1 = 2...10V / 4...20mA
P3.10	Exp. AI custom. min	-100.00	100.00	%	0.00	1842	Custom range min signal level
P3.11	Exp. AI custom. max	-100.00	300.00	%	100.00	1843	Custom range max signal level
P3.12	Exp. AI signal filter time	0.0	10.0	s	0.1	1844	Filter time for analogue input

Table 7. Analogue inputs group.

NOTE!

Visibility of the group depends on P1.16. Parameters P3.9 - P3.12 are shown only when expansion board OPTB4 is installed.

2.3.4 GROUP DIGITAL INPUTS: MENU PAR G4

Code	Parameter	Min	Max	Unit	Default	ID	Description
P4.1	Start signal 1	0	6*		1	403	Start signal 1 when control place is I/O 1 (FWD) See P2.1 for function. 0 = not used 1 = DIN1 2 = DIN2 3 = DIN3 4 = DIN4 5 = DIN5 6 = DIN6
P4.2	Start signal 2	0	6*		2	404	Start signal 2 when control place is I/O 1 (REV). See P2.1 for function. See P4.1 for selections.
P4.3	Reverse	0	6*		0	412	Independent from P2.1 See P4.1 for selections
P4.4	External fault close	0	6*		0	405	Fault if signal high See P4.1 for selections
P4.5	External fault open	0	6*		0	406	Fault is signal low See P4.1 for selections
P4.6	Fault reset	0	6*		5	414	Resets all active faults
P4.7	Run enable	0	6*		0	407	Must be on to set drive in Ready state
P4.8	Preset frequency selection 0	0	6*		3	419	Binary selector for Preset speeds (0-7).
P4.9	Preset frequency selection 1	0	6*		4	420	Binary selector for Preset speeds (0-7).
P4.10	Preset frequency selection 2	0	6*		0	421	Binary selector for Preset speeds (0-7).
P4.11	Acc/dec ramp selection	0	6*		6	408	Activates ramp 2 See P4.1 for selections
P4.12	Motor potentiometer UP	0	6*		0	418	Reference increase See P4.1 for selections
P4.13	Motor potentiometer DOWN	0	6*		0	417	Reference decrease See P4.1 for selections
P4.14	Control Place 2	0	6*		0	1813	Activates control place 2 See P4.1 for selections
P4.15	Frequency reference 2	0	6*		0	1814	Activates reference 2 See P4.1 for selections
P4.16	PID fixed setpoint 2	0	6*		0	431	Activates setpoint 2 See P4.1 for selections
P4.17	Quick Stop open	0	6*		0	1888	If configured, low signal activates stop with specific ramp. See P4.1 for selections.

Table 8. Digital inputs parameters.

NOTE!	(*)The maximum value is higher when an optional board with digital inputs is installed (see chapter 1.3). Parameter is automatically reset if value is greater than present limit.
NOTE!	Visibility of the group depends on P1.16.

2.3.5 GROUP DIGITAL OUTPUTS: MENU PAR G5

Code	Parameter	Min	Max	Unit	Default	ID	Description
P5.1	R01 function	0	14		2	313	Function selection for R01: 0 = Not used 1 = Ready 2 = Run 3 = General fault 4 = General fault inverted 5 = Warning 6 = Reversed 7 = At speed 8 = Output freq. supervision 9 = Output current superv. 10 = Analogue input superv. 11 = Fieldbus 1 12 = Fieldbus 2 13 = External brake 14 = Temperature supervision (OPTBH)
P5.2	R02 function	0	14		3	314	See P5.1
P5.3	D01 function	0	14		1	312	See P5.1
P5.4	R01 ON delay	0.00	320.00	s	0.00	458	ON delay for relay
P5.5	R01 OFF delay	0.00	320.00	s	0.00	459	OFF delay for relay
P5.6	R01 inversion	0	1		0	1804	0 = no inversion 1 = inverted
P5.7	R02 ON delay	0.00	320.00	s	0.00	460	See P5.4
P5.8	R02 OFF delay	0.00	320.00	s	0.00	461	See P5.5
P5.9	Exp. R01/E01 function	0	14		0	1826	Parameter visible when a I/O expansion board is installed. See P5.1 for selection
P5.10	Exp. R02/E02 function	0	14		0	1827	See P5.9
P5.11	Exp. R03/E03 function	0	14		0	1828	See P5.9
P5.12	Exp. D01 function	0	14		0	1872	See P5.9

Table 9. Digital outputs parameters.

NOTE!	<p>Visibility of the group depends on P1.16.</p> <p>P5.9 is visible when OPTB2, OPTB5, OPTB9 or OPTBF is installed (R01).</p> <p>P5.10 is visible when OPTB2 or OPTB5 is installed (R02).</p> <p>P5.11 is visible when OPTB5 is installed (R03).</p> <p>P5.9, P5.10, P5.11 are also visible when OPTB1 is installed and some outputs have been set with P2.24 (E01, E02, E03).</p> <p>P5.12 is visible when OPTBF is installed.</p> <p>Selection 14 as output function requires OPTBH board installed.</p>
--------------	--

2.3.6 GROUP ANALOGUE OUTPUTS: MENU PAR G6

Code	Parameter	Min	Max	Unit	Default	ID	Description
P6.1	A01 function	0	8		2	307	0 = Not used (fixed 100%) 1 = Freq. reference (0-fmax) 2 = Output freq. (0 -fmax) 3 = Motor speed (0 - Speed max) 4 = Output current (0-I _{nMotor}) 5 = Motor torque (0-T _{nMotor}) 6 = Motor power (0-P _{nMotor}) 7 = PID output (0-100%) 8 = Fieldbus(0-10000)
P6.2	A01 minimum	0	1		0	310	0 = 0V 1 = 2V
P6.3	A01 Output scale	0,0	1000,0	%	100.0	311	Scaling factor
P6.4	A01 filter time	0.00	10.00	s	0.10	308	Filtering time of analogue output signal. 0 = No filtering
P6.5	Exp. A01 function	0	8		2	1844	See P5.1
P6.6	Exp. A01 minimum	0	1		0	1845	0 = 0 mA 1 = 4 mA
P6.7	Exp. A01 Output scale	0,0	1000,0	%	100.0	1846	Scaling factor
P6.8	Exp. A01 filter time	0.00	10.00	s	0.10	1847	Filtering time of analogue output signal. 0 = No filtering
P6.9	Exp. A02 function	0	8		2	1848	See P6.1
P6.10	Exp. A02 minimum	0	1		0	1849	0 = 0 mA 1 = 4 mA
P6.11	Exp. A02 Output scale	0,0	1000,0	%	100.0	1850	Scaling factor
P6.12	Exp. A02 filter time	0.00	10.00	s	0.10	1851	Filtering time of analogue output signal. 0 = No filtering

Table 10. Analogue outputs parameters.

NOTE!	<p>Visibility of the group depends on P1.16.</p> <p>Parameters P6.5 - P6.18 are shown only when expansion board OPTB4 or OPTBF is installed.</p> <p>Parameters P6.9 - P6.12 are shown only when expansion board OPTB4 is installed.</p>
--------------	---

2.3.7 GROUP SUPERVISIONS: MENU PAR G7

Code	Parameter	Min	Max	Unit	Default	ID	Description
P7.1	Output frequency supervision	0	2		0	315	0 = not used 1 = Low limit 2 = High limit
P7.2	Frequency supervision limit	0.00	P1.2	Hz	0.00	316	Output frequency supervision threshold
P7.3	Current supervision limit	0.00	$2 \times I_H$	A	0.00	1811	Current supervision threshold
P7.4	Analogue input supervision	0	2		0	356	0 = AI1 1 = AI2 2 = AIE (if option OPTB4)
P7.5	AI supervision ON level	0.00	100.00	%	80.00	357	ON threshold AI supervision
P7.6	AI supervision OFF level	0.00	100.00	%	40.00	358	OFF threshold AI supervision
P7.7	External brake open frequency	0.00	10.00	Hz	2.00	1808	Frequency threshold for brake open
P7.8	External brake open current	0.0	100.0	%	30.0	1810	Current threshold for brake open
P7.9	External brake close frequency	0.00	10.00	Hz	2.00	1809	Frequency threshold for brake close (Start = 0)
P7.10	Process display source selection	0	5		2	1036	Selection of variable proportional to process: 0 = PID feedback value 1 = Output frequency 2 = Motor speed 3 = Motor torque 4 = Motor power 5 = Motor current
P7.11	Process display decimal digits	0	3		1	1035	Decimals on display
P7.12	Process display max value	0.0	3276.7		100.0	1034	Process display max value(it depends on P7.11: with zero decimal digit the max value is 32767; with 1 decimal digit the max value is 3276.7)

Table 11. Supervision parameters.

NOTE!	Visibility of the group depends on P1.16.
--------------	---

2.3.8 GROUP MOTOR CONTROL: MENU PAR G8

Code	Parameter	Min	Max	Unit	Default	ID	Description
P8.1	Motor control mode(*)	0	1		0	600	0 = Frequency control 1 = Speed control
P8.2	Field Weakening Point frequency	30.00	320.00	Hz	50.00	602	Field weakening point frequency
P8.3	Field Weakening Point voltage	10.00	200.00	%	100.00	603	Voltage at FWP as % of Motor nominal voltage
P8.4	U/f ratio selection(*)	0	2		0	108	0 = linear 1 = quadratic 2 = programmable
P8.5	U/f midpoint frequency(*)	0.00	P8.2	Hz	50.00	604	Midpoint frequency for programmable U/f curve
P8.6	U/f midpoint voltage(*)	0.00	P8.3	%	100.00	605	Midpoint voltage for programmable U/f curve
P8.7	Zero frequency voltage(*)	0.00	40.00	%	0.00	606	Voltage at 0,00 Hz as % of Motor nominal voltage
P8.8	Switching frequency	1.5	16.0	kHz	6.0	601	Motor noise can be minimized using a high switching frequency. Increasing the switching frequency reduces the capacity of the drive. It is recommended to use a lower frequency when the motor cable is long in order to minimize capacitive currents in the cable.
P8.9	Brake chopper	0	2		0	504	0 = Disabled 1 = Enabled in RUN 2 = Enabled in READY
P8.10	Brake chopper level	600	900	V	765	1807	DC-link voltage to start chopper.
P8.11	DC brake current	0.3 x I _H	2 x I _H	A	I _H	507	Defines the current injected into the motor during DC-braking. 0 = Disabled
P8.12	DC braking time at stop	0.00	600.00	s	0.00	508	Determines if braking is ON or OFF and the braking time of the DC-brake when the motor is stopping.
P8.13	Frequency to start DC braking at ramp stop	0.10	10.00	Hz	1.50	515	The output frequency at which the DC-braking is applied.
P8.14	Start magnetizing time	0.00	600.00	s	0.00	516	This parameter defines the time for how long DC current is fed to motor before acceleration starts.
P8.15	RS voltage drop(*)	0.00	100.00	%	0.00	662	Voltage drop on the motor windings as % of Motor nominal voltage
P8.16	Motor Identification	0	1		0	631	0 = not active 1 = standstill identification (to activate, RUN command within 20s)

P8.17	Overvoltage controller	0	1		0	1853	0 = Enabled 1 = Disabled
P8.18	Undervoltage controller	0	1		0	1854	0 = Enabled 1 = Disabled
P8.19	Switching frequency controller	0	1		0	1855	0 = Enabled 1 = Disabled

Table 12. Motor control parameters.

NOTE!	(*) Parameter is automatically set by motor identification.
NOTE!	Visibility of the group depends on P1.16.

2.3.9 GROUP PROTECTIONS: MENU PAR G9

NOTE!	Visibility of the group depends on P1.16.
--------------	---

Parameters of Motor thermal protection (P9.11 to P9.14 and P9.21-P9.22)

The motor thermal protection is to protect the motor from overheating. The drive is capable of supplying higher than nominal current to the motor. If the load requires this high current there is a risk that the motor will be thermally overloaded. This is the case especially at low frequencies. At low frequencies the cooling effect of the motor is reduced as well as its capacity. If the motor is equipped with an external fan the load reduction at low speeds is small.

The motor thermal protection is based on a calculated model and it uses the output current of the drive to determine the load on the motor.

The motor thermal protection can be adjusted with parameters. The thermal current I_T specifies the load current above which the motor is overloaded. This current limit is a function of the output frequency.

The thermal stage of the motor can be monitored on the control keypad display. See chapter 1.



If you use long motor cables (max. 100m) together with small drives (≤ 1.5 kW) the motor current measured by the drive can be much higher than the actual motor current due to capacitive currents in the motor cable. Consider this when setting up the motor thermal protection functions.



The calculated model does not protect the motor if the airflow to the motor is reduced by blocked air intake grill. The model starts from zero if the control board is powered off.

Parameters of Stall protection (P9.4 to P9.6)

The motor stall protection protects the motor from short time overload situations such as one caused by a stalled shaft. The reaction time of the stall protection can be set shorter than that of motor thermal protection. The stall state is defined with two parameters, P9.5 (*Stall time*) and P9.6 (*Stall frequency limit*). If the current is as high as the P1.5 (Current Limit) and the current limiter has reduced the output frequency below the P9.6 for the time P9.5 than the set limit the stall state is true. There is actually no real indication of the shaft rotation. Stall protection is a type of overcurrent protection.



If you use long motor cables (max. 100m) together with small drives (≤ 1.5 kW) the motor current measured by the drive can be much higher than the actual motor current due to capacitive currents in the motor cable. Consider this when setting up the motor thermal protection functions.

Parameters of Underload protection (P9.7 to P9.10)

The purpose of the motor underload protection is to ensure that there is load on the motor when the drive is running. If the motor loses its load there might be a problem in the process, e.g. a broken belt or a dry pump.

Motor underload protection can be adjusted by setting the underload curve with parameters P9.8 (Underload protection: Field weakening area load) and P9.9 (*Underload protection: Zero frequency load*), see below. The underload curve is a squared curve set between the zero fre-

quency and the field weakening point. The protection is not active below 5Hz (the underload time counter is stopped).

The torque values for setting the underload curve are set in percentage which refers to the nominal torque of the motor. The motor's name plate data, parameter motor nominal current and the drive's nominal current I_L are used to find the scaling ratio for the internal torque value. If other than nominal motor is used with the drive, the accuracy of the torque calculation decreases.



If you use long motor cables (max. 100m) together with small drives (≤ 1.5 kW) the motor current measured by the drive can be much higher than the actual motor current due to capacitive currents in the motor cable. Consider this when setting up the motor thermal protection functions.

Code	Parameter	Min	Max	Unit	Default	ID	Description
P9.1	Analogue input fault (< 4mA)	0	4		1	700	0 = No action 1 = Warning 2 = Fault 3 = Warning if Start active 4 = Fault if Start active
P9.2	Analogue input fault delay	0.0	10.0	s	0.5	1430	Time limit
P9.3	Earth fault	0	2		2	703	0 = No action 1 = Warning 2 = Fault
P9.4	Motor stall fault	0	2		1	709	See P9.3
P9.5	Stall time limit	0.0	300.0	s	5.0	711	This is the maximum time allowed for a stall stage.
P9.6	Stall frequency limit	0.10	320.00	Hz	15.00	712	For a stall state to occur, the output frequency must have remained below this limit for a certain time.
P9.7	Underload fault	0	2		0	713	See P9.3
P9.8	Underload protection: Field weakening area load	10.0	150.0	%	50.0	714	This parameter gives the value for the minimum torque allowed when the output frequency is above the field weakening point.
P9.9	Underload fault: Zero frequency load	5.0	150.0	%	10.0	715	This parameter gives value for the minimum torque allowed with zero frequency.
P9.10	Underload fault: Time limit	1.0	300.0	s	20.0	716	This is the maximum time allowed for an underload state to exist.
P9.11	Motor thermal fault	0	2		2	704	See P9.3
P9.12	Motor ambient temperature factor	-20	100	°C	40	705	Ambient temperature in °C
P9.13	Motor thermal zero speed cooling	0.0	150.0	%	40.0	706	Defines the cooling factor at zero speed in relation to the point where the motor is running at nominal speed without external cooling.

P9.14	Motor thermal time constant	1	200	min	45	707	The time constant is the time within which the calculated thermal stage has reached 63% of its final value.
P9.15	Fieldbus communication fault	0	2		2	733	See P9.3
P9.16	Thermistor fault	0	2		2	732	See P9.3 Available only if OPTB2 option board is installed.
P9.17	Parameter edit lock	0	1		0	1805	0 = Edit enabled 1 = Edit disabled
P9.18	Response to Safe Torque Off	0	3		1	1876	0 = No action 1 = Warning 2 = Fault, not stored in history menu 3 = Fault, stored in history menu
P9.19	Input phase fault	0	2		2	1877	See P9.3
P9.20	Input phase fault ripple limit	0	75		0	1893	0 = internal value 1 = max sensivity -> 75 = min sensivity
P9.21	Motor temperature initialization	0	2		2	1891	0 = start from minimum 1 = start from costant value 2 = start from last value
P9.22	Motor temperature inital value	0	100	%	33	1892	Initial value(P9.21 = 1) or factor for last previous value(P9.21 = 2)

Table 13. Protections settings

2.3.10 GROUP AUTOMATIC RESET: MENU PAR G10

Code	Parameter	Min	Max	Unit	Default	ID	Description
P10.1	Automatic reset	0	1		0	731	0 = Disabled 1 = Enabled
P10.2	Wait time	0.10	10.0	s	0.50	717	Wait time before the first reset is executed.
P10.3	Trial time	0.00	60.0	s	30.00	718	When the trial time has elapsed, and the fault is still active, the drive will trip to fault.
P10.4	Number of trials	1	10		3	759	NOTE: Total number of trials (irrespective of fault type)
P10.5	Restart function	0	2		0	719	The start mode for Automatic reset is selected with this parameter: 0 = Ramp 1 = Flying start 2 = According to par. P1.13

Table 14. Autoreset settings.

NOTE!	Visibility of the group depends on P1.16.
--------------	---

2.3.1.1 GROUP FIELDBUS: MENU PAR G11

Code	Parameter	Min	Max	Unit	Default	ID	Description
P11.1	Fieldbus Data OUT 1 selection	0	16		0	852	Variable mapped on PD1: 0 = Output current 1 = Motor speed 2 = Motor current 3 = Motor voltage 4 = Motor torque 5 = Motor power 6 = DC-link voltage 7 = Active fault code 8 = Analogue AI1 9 = Analogue AI2 10 = Digital inputs state 11 = PID feedback value 12 = PID setpoint 13 = Analogue AI3 14 = Temperature 1 15 = Temperature 2 16 = Temperature 3
P11.2	Fieldbus Data OUT 2 selection	0	16		1	853	Variable mapped on PD2. See P11.1
P11.3	Fieldbus Data OUT 3 selection	0	16		2	854	Variable mapped on PD3. See P11.1
P11.4	Fieldbus Data OUT 4 selection	0	16		4	855	Variable mapped on PD4. See P11.1
P11.5	Fieldbus Data OUT 5 selection	0	16		5	856	Variable mapped on PD5. See P11.1
P11.6	Fieldbus Data OUT 6 selection	0	16		3	857	Variable mapped on PD6. See P11.1
P11.7	Fieldbus Data OUT 7 selection	0	16		6	858	Variable mapped on PD7. See P11.1
P11.8	Fieldbus Data OUT 8 selection	0	16		7	859	Variable mapped on PD8. See P11.1
P11.9	Aux CW Data IN sel.	0	5		0	1821	PDI for Aux CW 0 = Not used 1 = PDI1 2 = PDI2 3 = PDI3 4 = PDI4 5 = PDI5
P11.10	PID Setpoint Data IN sel.	0	5		1	1822	PDI for PID Setpoint See P11.9
P11.11	PID Feedback Data IN sel.	0	5		2	1823	PDI for PID Feedback See P11.9
P11.12	Analogue Out CTRL Data IN sel.	0	5		3	1824	PDI for Analogue Out CTRL See P11.9

Table 15. Fieldbus data mapping.

NOTE!	<p>Visibility of the group depends on P1.16.</p> <p>Selection 13 as data out requires board OPTB4 installed.</p> <p>Selections 14, 15, 16 as data out require board OPTBH installed.</p>
--------------	--

2.3.12 GROUP PID-CONTROLLER: MENU PAR G12

Code	Parameter	Min	Max	Unit	Default	ID	Description
P12.1	Setpoint source selection	0	3		0	332	0 = Fixed setpoint 1/2 1 = AI1 2 = AI2 3 = Fieldbus
P12.2	Fixed setpoint 1	0.0	100.0	%	50.0	167	Fixed setpoint 1
P12.3	Fixed setpoint 2	0.0	100.0	%	50.0	168	Fixed setpoint 2
P12.4	Feedback source selection	0	4		0	334	0 = AI2 1 = AI1 2 = Fieldbus 3 = AI1- AI2 4 = Temperature(OPTBH)
P12.5	Feedback minimum	0.0	50.0	%	0.0	336	Value at minimum signal
P12.6	Feedback maximum	10.0	300.0	%	100.0	337	Value at maximum signal
P12.7	PID gain	0.0	1000.0	%	100.0	118	If the value of the parameter is set to 100% a change of 10% in the error value causes the controller output to change by 10%.
P12.8	PID integration time	0.00	320.00	s	10.00	119	If this parameter is set to 1,00 second a change of 10% in the error value causes the controller output to change by 10.00%/s.
P12.9	PID derivation time	0.00	10.00	s	0.00	132	If this parameter is set to 1,00 second a change of 10% in the error value during 1.00 s causes the controller output to change by 10.00%.
P12.10	Regulation inversion	0	1		0	340	0 = Normal (Feedback < Setpoint -> Increase PID output) 1 = Inverted (Feedback < Setpoint -> Decrease PID output)
P12.11	PID max error	0.0	100.0	%	100.0	1812	Limit on error
P12.12	Sleep frequency limit	0.00	P1.2	Hz	0.00	1016	Drive goes to sleep mode when the output frequency stays below this limit for a time greater than that defined by parameter P12.13.
P12.13	Sleep delay	0	3600	s	30	1017	The minimum amount of time the frequency has to remain below the Sleep level before the drive is stopped.
P12.14	Wake-up level	0.0	100.0	%	5.0	1018	Defines the level for the PID feedback value wake-up.
P12.15	Sleep setpoint boost	0.0	50.0	%	10.0	1815	Referred to setpoint
P12.16	Sleep boost time	0	60	s	10	1816	Boost time after P12.13
P12.17	Sleep max loss	0.0	50.0	%	5.0	1817	Referred to feedback after boost
P12.18	Sleep loss check time	1	300	s	30	1818	After boost time P12.16

Table 16. PID controller parameters.

NOTE!	This group is hidden when PID output is not used as frequency reference.
--------------	--

2.3.13 GROUP TEMPERATURE MEASUREMENT: MENU PAR G13

Code	Parameter	Min	Max	Unit	Default	ID	Description
P13.1	Temperature unit	0	1		0	1863	0 = °C 1 = °K
P13.2	Superv/Fault sensor select	0	6		0	1873	0= T1 1= T2 2= T1 + T2 3= T3 4= T3 + T1 5= T3 + T2 6= T3 + T2 + T1
P13.3	Supervision mode	0	2		1	1864	0: not used 1: over threshold 2: below threshold
P13.4	Fault mode	0	2		0	1865	0: not used 1: over threshold 2: below threshold
P13.5	Supervision level	-30.0 223.2	200.0 473.2	°C °K	80.0	1867	Threshold for supervision
P13.6	Fault level	-30.0 223.2	200.0 473.2	°C °K	100.0	1866	Threshold for fault
P13.7	Superv/fault Hysteresis	0.0	50.0	°C °K	2.0	1868	Hysteresis for state change
P13.8	Refer/Actual sensor select	0	6		0	1869	0= T1 1= T2 2= T3 3= max(T1,T2) 4= min(T1,T2) 5= max(T1, T2, T3) 6= min(T1, T2, T3)
P13.9	Min Ref/Actual temperature	-30.0 223.2	200.0 473.2	°C °K	0.0	1870	Temperature for min reference/actual
P13.10	Max Ref/Actual temperature	-30.0 223.2	200.0 473.2	°C °K	100.0	1871	Temperature for max reference/actual

Table 17. Temperature measurement parameters.

NOTE!	This group is hidden when board OPTBH is not installed.
--------------	---

2.4 SYSTEM PARAMETERS, FAULTS AND HISTORY FAULTS: MENU FLT

Code	Parameter	Min	Max	Unit	Default	ID	Description
V1.1	API system SW ID					2314	
V1.2	API system SW version					835	
V1.3	Power SW ID					2315	
V1.4	Power SW version					834	
V1.5	Application ID					837	
V1.6	Application revision					838	
V1.7	System load					839	
When no fieldbus board has been installed, the following values are visible:							
V2.1	Communication status					808	Status of Modbus communication. Format: xx.yyy where xx = 0 - 64 (Number of error messages) yyy = 0 - 999 (Number of good messages)
P2.2	Fieldbus protocol	0	1		0	809	0 = Not used 1 = Modbus used
P2.3	Slave address	1	255		1	810	
P2.4	Baud rate	0	8		5	811	0 = 300 1 = 600 2 = 1200 3 = 2400 4 = 4800 5 = 9600 6 = 19200 7 = 38400 8 = 57800
P2.6	Parity type	0	2		0	813	0 = None 1 = Odd 2 = Even
P2.7	Communication time out	0	255	s	0	814	
P2.8	Reset communication status	0	1		0	815	
When OPTE6 (CANopen) option board has been installed, the following values are visible:							
V2.1	CANopen communication status					14004	
P2.2	CANopen operation mode	1	2		1	14003	
P2.3	CANopen Node ID	1	127		1	14001	
P2.4	CANopen baud rate	1	8		6	14002	
When OPTE7 (DeviceNet) option board has been installed, the following values are visible:							
V2.1	DeviceNet communication status					14014	
P2.2	Output assembly type	20	111		21	14012	
P2.3	MAC ID	0	63		63	14010	
P2.4	Baud Rate	1	3		1	14011	

Table 18. System parameters, Faults and History faults.

P2.5	Input assembly type	70	117		71	14013	
When OPTE3/E5(Profibus) option board has been installed, the following values are visible:							
V2.1	Profibus communication status					14022	
P2.2	Fieldbus protocol					14023	
P2.3	Active protocol					14024	
P2.4	Active baud rate					14025	
P2.5	Telegram type					14027	
P2.6	Operate mode	1	3		1	14021	
P2.7	Slave address	2	126		126	14020	
When OPTCI (Modbus TCP) option board has been installed, the following values are visible:							
P2.1	Comm. Timeout	0			0	14050	
P2.2	IP Part 1	0			192	14030	
P2.3	IP Part 2	0			168	14031	
P2.4	IP Part 3	0			0	14032	
P2.5	IP Part 4	0			10	14033	
P2.6	Subnet mask P1	0			255	14034	
P2.7	Subnet mask P2	0			255	14035	
P2.8	Subnet mask P3	0			0	14036	
P2.9	Subnet mask P4	0			0	14037	
P2.10	Default GW P1	0			192	14038	
P2.11	Default GW P2	0			168	14039	
P2.12	Default GW P3	0			0	14040	
P2.13	Default GW P4	0			1	14041	
When OPTCP (Profinet) option board has been installed, the following values are visible:							
P2.1	Comm. Timeout	0			0	14050	
P2.2	IP Part 1	0			192	14030	
P2.3	IP Part 2	0			168	14031	
P2.4	IP Part 3	0			0	14032	
P2.5	IP Part 4	0			10	14033	
P2.6	Subnet mask P1	0			255	14034	
P2.7	Subnet mask P2	0			255	14035	
P2.8	Subnet mask P3	0			0	14036	
P2.9	Subnet mask P4	0			0	14037	
P2.10	Default GW P1	0			192	14038	
P2.11	Default GW P2	0			168	14039	
P2.12	Default GW P3	0			0	14040	
P2.13	Default GW P4	0			1	14041	
When OPTCQ (Ethernet IP) option board has been installed, the following values are visible:							
P2.1	Comm. Timeout	0			0	14056	
P2.2	IP Part 1	0			192	14030	
P2.3	IP Part 2	0			168	14031	
P2.4	IP Part 3	0			0	14032	
P2.5	IP Part 4	0			10	14033	
P2.6	Subnet mask P1	0			255	14034	

Table 18. System parameters, Faults and History faults.

P2.7	Subnet mask P2	0			255	14035	
P2.8	Subnet mask P3	0			0	14036	
P2.9	Subnet mask P4	0			0	14037	
P2.10	Default GW P1	0			192	14038	
P2.11	Default GW P2	0			168	14039	
P2.12	Default GW P3	0			0	14040	
P2.13	Default GW P4	0			1	14041	
P2.14	Output Assembly	0			21	14057	
P2.15	Input Assembly	0			71	14058	
When OPTC4 (Lonworks) option board has been installed, the following values are visible:							
P2.1	Service PIN	0			0	14217	Broadcasts a service pin message to the network.
When OPTBH option board has been installed, the following values are visible:							
P2.1	Sensor 1 type	0	6		0	14072	
P2.2	Sensor 2 type	0	6		0	14073	
P2.3	Sensor 3 type	0	6		0	14073	
Other information:							
V3.1	MWh counter					827	
V3.2	Power on day counter					828	
V3.3	Power on hour counter					829	
V3.4	RUN day counter					840	
V3.5	RUN hour counter					841	
V3.6	Fault conter					842	
V3.7	Panel parameter set status monitor						Hidden when PC is connected
P4.2	Restore factory defaults	0	1		0	831	1 = Restore factory defaults for all parameters
P4.3	Password	0	9999		0000	832	
P4.4	Time for keypad backlight	0	99	min	5	833	
P4.5	Save parameters to Keypad	0	1		0		1= Upload all parameters to Keypad Hidden when PC is connected. This function works properly only with drive supplied.
P4.6	Download parameters from Keypad	0	1		0		1= Download all parameters to Keypad Hidden when PC is connected. This function works properly only with drive supplied.
F5.x	Active fault menu	0	9				
F6.x	Fault history menu	0	9				

Table 18. System parameters, Faults and History faults.

3. PARAMETER DESCRIPTION

Due to its user-friendliness and simplicity of use, the most parameters only require a basic description which is given in the parameter tables in chapter 2.2.

In this chapter, you will find additional information on certain most advanced parameters. Should you not find the information you need contact your distributor.

3.1 BASIC PARAMETERS

P1.1 MIN FREQUENCY

Minimum frequency reference.

NOTE: if motor current limit is reached, actual output frequency might be lower than parameter. If this is not acceptable, stall protection should be activated.

P1.2 MAX FREQUENCY

Maximum frequency reference.

P1.3 ACCELERATION TIME 1

Ramp time, referred to variation from zero frequency to max frequency.

A second acceleration time is available in P2.5.

P1.4 DECELERATION TIME 1

Ramp time, referred to variation from max frequency to zero.

A second deceleration time is available in P2.6.

P1.5 MOTOR CURRENT LIMIT

This parameter determines the maximum motor current from the AC drive. The parameter value range differs from size to size.

When the current limit is active the drive output frequency is decreased.

NOTE: This is not an overcurrent trip limit.

P1.11 CONTROL PLACE SELECTION

Run and direction control. A second control place is programmable in P2.10.

0: I/O terminals

1: Keypad

2: Fieldbus

P1.12 FREQUENCY REFERENCE SELECTION

Defines the source of frequency reference. A second reference source is programmable in P2.10.

0: Analogue input AI1

1: Analogue input AI2

2: PID control

- 3: Motorpotentiometer
- 4: Keypad
- 5: Fieldbus
- 6: Expansion AI1 (only with board OPTB4)
- 7: Temperature (only with board OPTBH, see P13.8-10)

P1.13 START FUNCTION

- 0: Ramping
- 1: Flying start

P1.14 STOP FUNCTION

Selection number	Selection name	Description
0	Coasting	The motor is allowed to stop on its own inertia. The control by the drive is discontinued and the drive current drops to zero as soon as the stop command is given.
1	Ramp	After the Stop command, the speed of the motor is decelerated according to the set deceleration parameters to zero speed.

NOTE: fall of Enable signal, when configured, always determines stop by coasting.

P1.15 U/F CURVE OPTIMIZATION

- 0: Not used
- 1: Automatic voltage boost (improves motor torque).

P1.16 SHOW ADVANCED PARAMETERS

- 0: Only Basic group (and PI Control if function is used)
- 1: All parameters groups are visible.

3.2 ADVANCED SETTINGS

P2.1 START/DIRECTION LOGIC

These logics are based on Start sgn1 and Start sgn 2 signals (defined with P4.1 and P4.2). Usually they are coupled to inputs DIN1 and DIN2.

Values 0...3 offer possibilities to control the starting and stopping of the AC drive with digital signal connected to digital inputs.

The selections including the text 'edge' shall be used to exclude the possibility of an unintentional start when, for example, power is connected, re-connected after a power failure, after a fault reset, after the drive is stopped by Run Enable (Run Enable = False) or when the control place is changed to I/O control. **The Start/Stop contact must be opened before the motor can be started.**

The used stop mode is *Coasting* in all examples.

Selection number	Selection name	Note
0	Start sgn 1: Start Forward Start sgn 2: Start Backward	The functions take place when the contacts are closed.

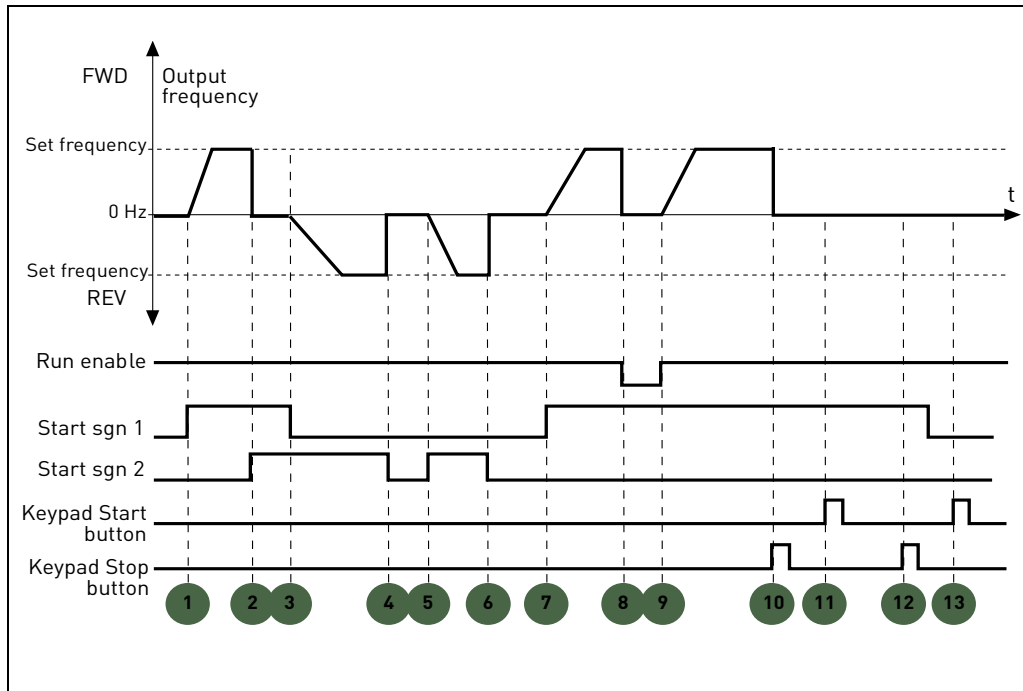

Figure 5. Start/Stop logic = 0.

Explanations:

1	Start sgn 1 activates causing the output frequency to rise. The motor runs forward.	8	Run enable signal is set to FALSE, which drops the frequency to 0. The run enable signal is configured with parameter P4.7.
2	Start sgn 2 activates causing the motor drops to 0. Warning 55 appears on the keypad.	9	Run enable signal is set to TRUE, which causes the frequency to rise towards the set frequency because Start sgn 1 is still active.
3	Start sgn 1 is inactivated which causes the direction to start changing (FWD to REV) because Start sgn 2 is still active.	10	Keypad stop button is pressed and the frequency fed to the motor drops to 0. (This signal only works if P2.22 Keypad stop button = 1)
4	Start sgn 2 inactivates and the frequency fed to the motor drops to 0.	11	Pushing the Start button on the keypad has no effect on the drive status.
5	Start sgn 2 activates again causing the motor to accelerate (REV) towards the set frequency.	12	The keypad stop button is pushed again to stop the drive.
6	Start sgn 2 inactivates and the frequency fed to the motor drops to 0.	13	The attempt to start the drive through pushing the Start button is not successful even if Start sgn 1 is inactive.
7	Start sgn 1 activates and the motor accelerates (FWD) towards the set frequency		

Selection number	Selection name	Note
1	Start sgn 1: Start Forward Start sgn 2: Reverse	The functions take place when the contacts are closed.

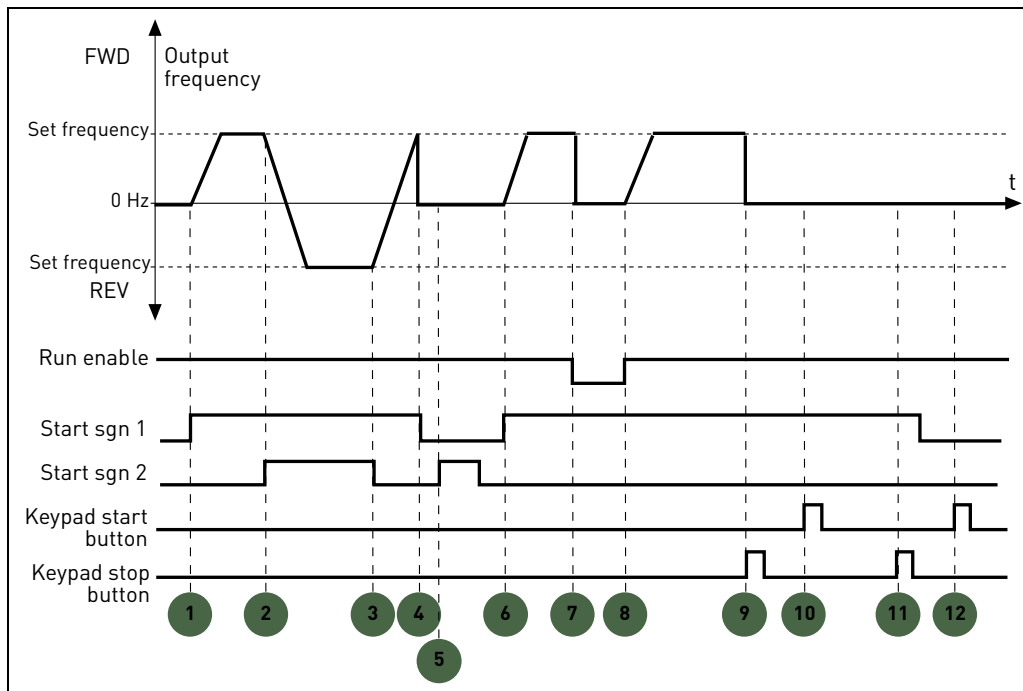

Figure 6. Start/Stop logic = 1.

Explanations:

1	Start sgn 1 activates causing the output frequency to rise. The motor runs forward.	7	Run enable signal is set to FALSE, which drops the frequency to 0. The run enable signal is configured with parameter P4.7.
2	Start sgn 2 activates which causes the direction to start changing (FWD to REV).	8	Run enable signal is set to TRUE, which causes the frequency to rise towards the set frequency because Start sgn 1 is still active.
3	Start sgn 2 is inactivated which causes the direction to start changing (REV to FWD) because Start sgn 1 is still active.	9	Keypad stop button is pressed and the frequency fed to the motor drops to 0. (This signal only works if P2.22 Keypad stop button = Yes)
4	Also Start sgn 1 inactivates and the frequency drops to 0.	10	Pushing the Start button on the keypad has no effect on the drive status.
5	Despite the activation of Start sgn 2, the motor does not start because Start sgn 1 is inactive.	11	The drive is stopped again with the stop button on the keypad.
6	Start sgn 1 activates causing the output frequency to rise again. The motor runs forward because Start sgn 2 is inactive.	12	The attempt to start the drive through pushing the Start button is not successful even if Start sgn 1 is inactive.

Selection number	Selection name	Note
2	Start sgn 1: Start pulse Start sgn 2: Stop pulse	The functions take place on the rising edge of the Start pulse and on the falling edge of the Stop pulse.

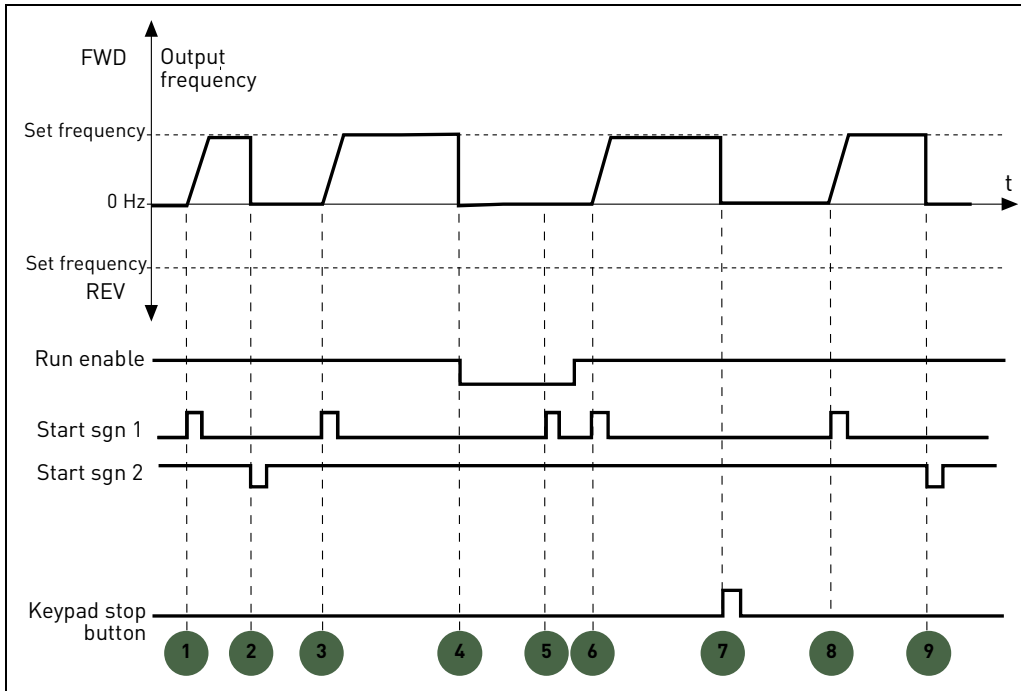

Figure 7. Start/Stop logic = 2.

Explanations:

1	Start sgn 1 activates causing the output frequency to rise. The motor runs forward.	6	Start sgn 1 activates and the motor accelerates (FWD) towards the set frequency because the Run enable signal has been set to TRUE.
2	Start sgn 2 inactivates causing the frequency to drop to 0.	7	Keypad stop button is pressed and the frequency fed to the motor drops to 0. (This signal only works if P2.22 Keypad stop button = Yes)
3	Start sgn 1 activates causing the output frequency to rise again. The motor runs forward.	8	Start sgn 1 activates causing the output frequency to rise again. The motor runs forward.
4	Run enable signal is set to FALSE, which drops the frequency to 0. The run enable signal is configured with parameter P4.7.	9	Start sgn 2 inactivates causing the frequency to drop to 0.
5	Start attempt with Start sgn 1 is not successful because Run enable signal is still FALSE.		

Selection number	Selection name	Note
3	Start sgn 1: Start Forward (edge) Start sgn 2: Start Backward (edge)	Shall be used to exclude the possibility of an unintentional start. The Start/Stop contact must be opened before the motor can be restarted.

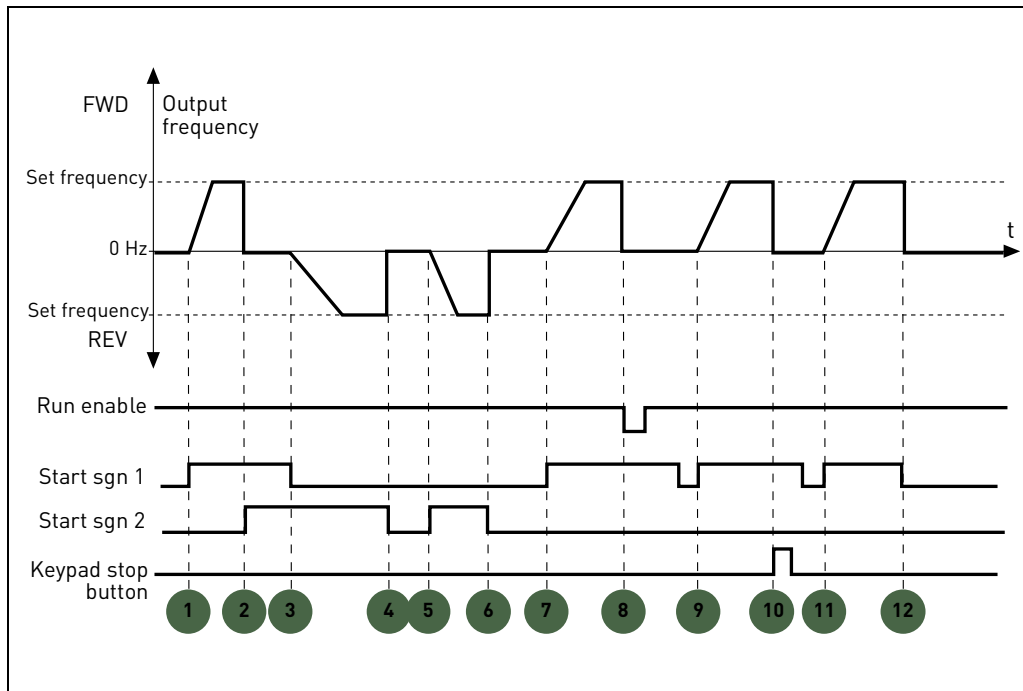

Figure 8. Start/Stop logic = 3.

Explanations:

1	Start sgn 1 activates causing the output frequency to rise. The motor runs forward.	7	Start sgn 1 activates and the motor accelerates (FWD) towards the set frequency
2	Start sgn 2 activates causing the motor drops to 0. Warning 55 appears on the keypad.	8	Run enable signal is set to FALSE, which drops the frequency to 0. The run enable signal is configured with parameter P4.7.
3	Start sgn 1 is inactivated which causes the direction to start changing (FWD to REV) because Start sgn 2 is still active.	9	Run enable signal is set to TRUE, which, unlike if value 0 is selected for this parameter, has no effect because rising edge is required to start even if Start sgn 1 is active.
4	Start sgn 2 inactivates and the frequency fed to the motor drops to 0.	10	Keypad stop button is pressed and the frequency fed to the motor drops to 0. (This signal only works if P2.22 Keypad stop button = Yes)
5	Start sgn 2 activates again causing the motor to accelerate (REV) towards the set frequency.	11	Start sgn 1 is opened and closed again which causes the motor to start.
6	Start sgn 2 inactivates and the frequency fed to the motor drops to 0.	12	Start sgn 1 inactivates and the frequency fed to the motor drops to 0.

P2.2 TO**P2.8 PRESET FREQUENCY 1 TO 7**

You can use the preset frequency parameters to define certain frequency references in advance. These references are then applied by activating/inactivating digital inputs connected to parameters P4.8, P4.9 and P4.10 (binary code). The values of the preset frequencies are automatically limited between the minimum and maximum frequencies.

Required action			Activated frequency
B2	B1	B0	Preset frequency 1
B2	B1	B0	Preset frequency 2
B2	B1	B0	Preset frequency 3
B2	B1	B0	Preset frequency 4
B2	B1		Preset frequency 5
B2	B1	B0	Preset frequency 6
B2	B1	B0	Preset frequency 7

Table 19. Selection of preset frequencies; ■ = input activated

P2.9 ACCELERATION TIME 2**P2.10 DECELERATION TIME 2**

Ramp 2 is activated through digital input defined in P4.11 or through fieldbus. Automatic selection based on output frequency is also available.

P2.11 THRESHOLD ACCELERATION TIME 2**P2.12 THRESHOLD DECELERATION TIME 2**

If P2.11 is not 0, acceleration time 2 is activated when output frequency is higher than the value.
If P2.12 is not 0, deceleration time 2 is activated when output frequency is higher than the value.

P2.13 S RAMP SHAPE

When value is greater than zero, acceleration and deceleration ramps have a S shape. The parameter is the time needed to reach full acc/dec.

The start and end of acceleration and deceleration ramps can be smoothed with this parameter. Setting value 0 gives a linear ramp shape which causes acceleration and deceleration to act immediately to the changes in the reference signal.

Setting value 0.1...10 seconds for this parameter produces an S-shaped acceleration/deceleration. The acceleration time is determined with parameters P1.3 and P1.4.

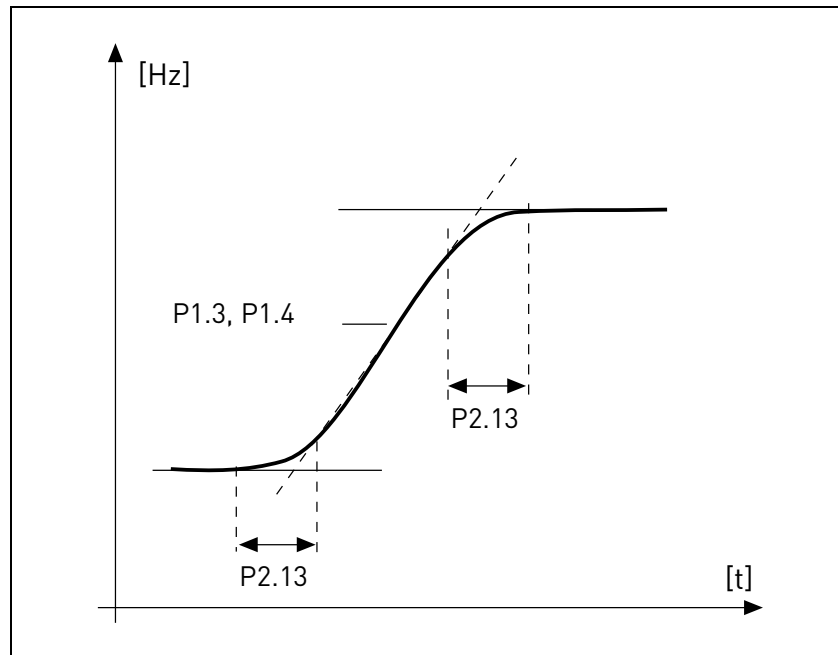

Figure 9. Acceleration/deceleration (S-shaped).

These parameters are used to reduce mechanical erosion and current spikes when the reference is changed.

P2.14 CONTROL PLACE SELECTION 2

Alternative Run and direction control. Activated by digital input defined in P4.14.

0: I/O terminals

1: Keypad

2: Fieldbus

P2.15 FREQUENCY REFERENCE SELECTION 2

Alternative source of frequency reference. Activated by digital input defined in P4.15 or fieldbus.

0: Analogue input AI1

1: Analogue input AI2

2: PID control

3: Motorpotentiometer

- 4: Keypad
- 5: Fieldbus
- 6: Expansion AI1 (only with board OPTB4)
- 7: Temperature (only with board OPTBH, see P13.8-10)

P2.16 MOTOR POTENTIOMETER RAMP

Speed variation ramp.

P2.17 MOTOR POTENTIOMETER MEMORY

- 0: No reset
- 1: Reset at stop and power down
- 2: Reset at power down

P2.18 SKIP FREQUENCY LOW 1**P2.19 SKIP FREQUENCY HIGH 1****P2.20 SKIP FREQUENCY LOW 2****P2.21 SKIP FREQUENCY HIGH 2**

Two skip frequency region are available, if it is needed to avoid certain frequencies because of mechanical resonance.

P2.22 PANEL STOP BUTTON

- 0: Active only in keypad control mode
- 1: Always active

P2.23 PANEL CONTROL DIRECTION

Effective when control is from panel

- 0: Forward
- 1: Backward

P2.24 OPTB1 DIGITAL INPUTS

This parameter is shown only when OPTB1 board is installed.

The number of terminals used as input should be programmed, so that the maximum value for parameters of group Digital Inputs is set accordingly.

Parameters for optional digital output functions are shown, if the number of inputs is lower than 6.

P2.25 QUICK STOP DECELERATION TIME

Specific ramp time for quick stop. To see description of P4.17 for details about the function.

3.3 ANALOGUE INPUTS

P3.1 AI1 RANGE

P3.5 AI2 RANGE

Range of the electrical signal.

0: 0-100%: 0...10V or 0... 20mA

1: 20-100%: 2...10V or 4... 20mA

P3.4 AI1 FILTER TIME

P3.8 AI2 FILTER TIME

Low pass filter time constant, to reduce noise. When this parameter is given a value greater than 0 the function that filters out disturbances from the incoming analogue signal is activated.

NOTE: Long filtering time makes the regulation response slower!

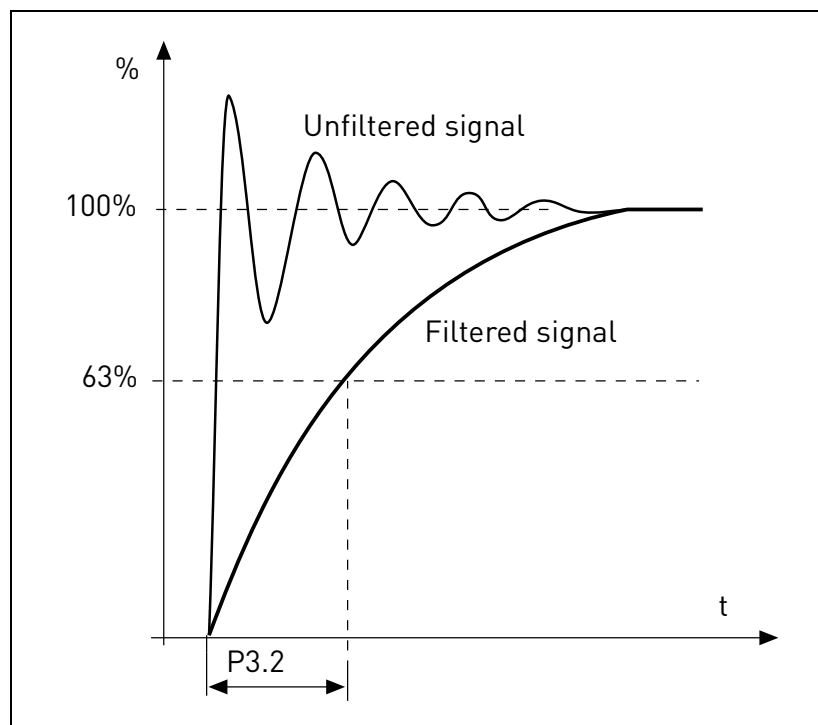

Figure 10.AI1 signal filtering.

P3.2 AI1 CUSTOM MIN

P3.6 AI2 CUSTOM MIN

Customized value for minimum signal. Effective when different than 0%

P3.3 AI1 CUSTOM MAX

P3.7 AI2 CUSTOM MAX

Customized value for maximum signal. Effective when different than 100%.

Example of custom range use with analogue input:

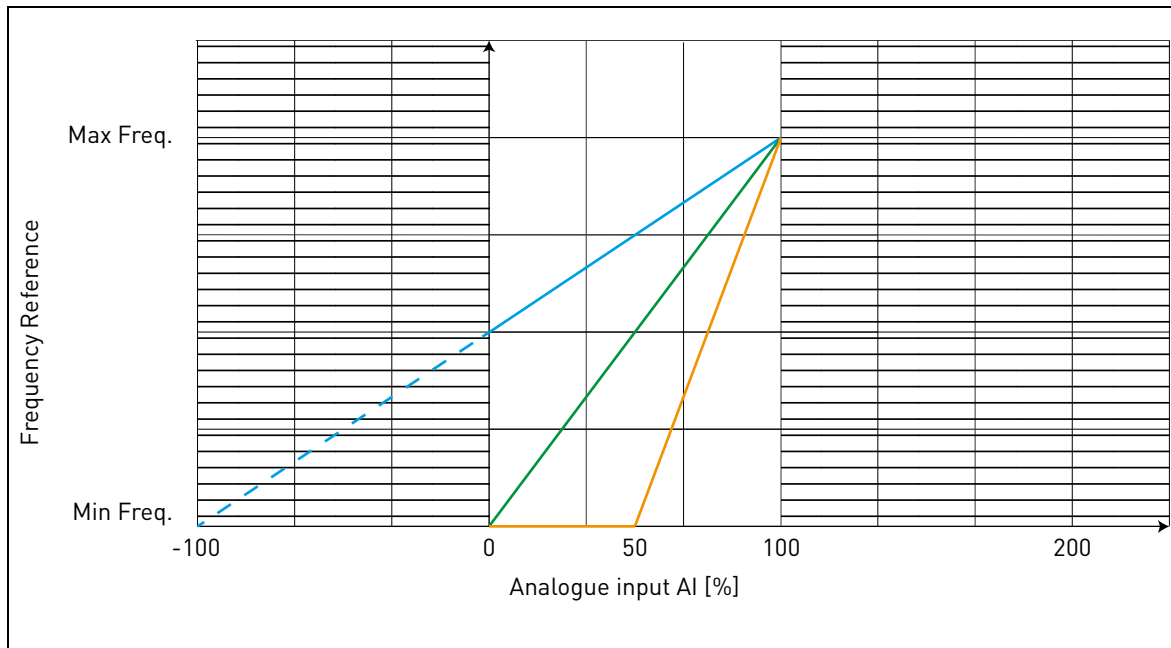

Figure 11.

Description of Figure 11.

Custom min and Custom max parameters configure the input range for analog input that will affect Frequency reference.

Blue line shows an example with Custom Min = -100% and Custom Max = 100%. This settings provides a frequency range between $(\text{Maximum frequency} - \text{Minimum frequency})/2$ and Maximum frequency. With minimum analogue signal the Frequency reference is at 50% of the set frequency range $(\text{Max frequency} - \text{Min frequency})/2$. With maximum analogue signal the Frequency reference is at Maximum frequency.

Green line shows the default settings of custom values: Custom Min = 0% and Custom Max = 100%. This settings provides a frequency range between Minimum and Maximum frequency. With minimum analogue signal the Frequency reference is at Minimum frequency while with the maximum level is at Maximum frequency.

Orange line shows an example with Custom min = 50% and Custom Max = 100%. These settings provides a frequency range between Minimum and Maximum frequency. The Frequency reference changes linearly within the frequency range with the analogue signal between 50% and 100% of its range.

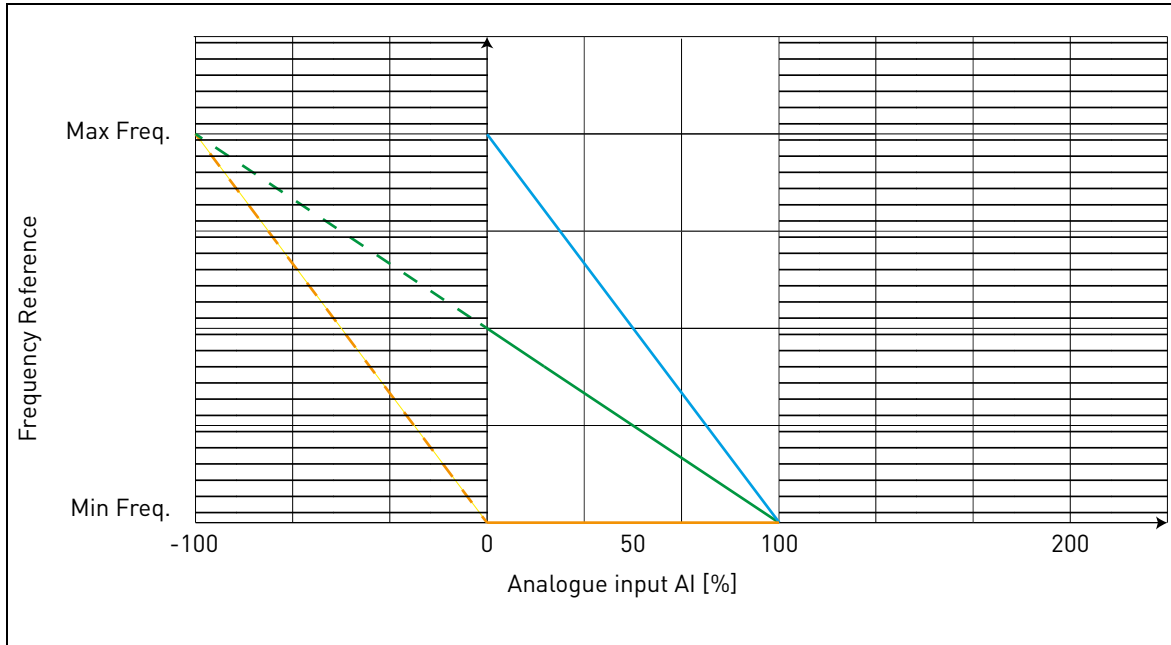

Figure 12.

Description of Figure 12:

Green line shows an example with Custom Min = 100% and Custom Max = -100%. This settings provides a frequency range between Minimum frequency and $(\text{Maximum frequency} - \text{Minimum frequency})/2$. With minimum analogue signal the Frequency reference is at 50% of the set frequency range $(\text{Max frequency} - \text{Min frequency})/2$, and with maximum analogue signal the Frequency reference is at Minimum frequency.

Blue line shows the inversion of the default settings of custom values: Custom Min =100% and Custom Max = 0%. This settings provides a frequency range between the Minimum frequency and the Maximum frequency. With minimum analogue signal the Frequency reference is Maximum frequency while with the maximum level is Minimum frequency.

Orange line shows an example with Custom min = -100% and Custom Max = 0%. This settings provides a frequency range between Minimum and Maximum frequency. The frequency reference is always at its minimum value (Minimum frequency) within the analogue signal range.

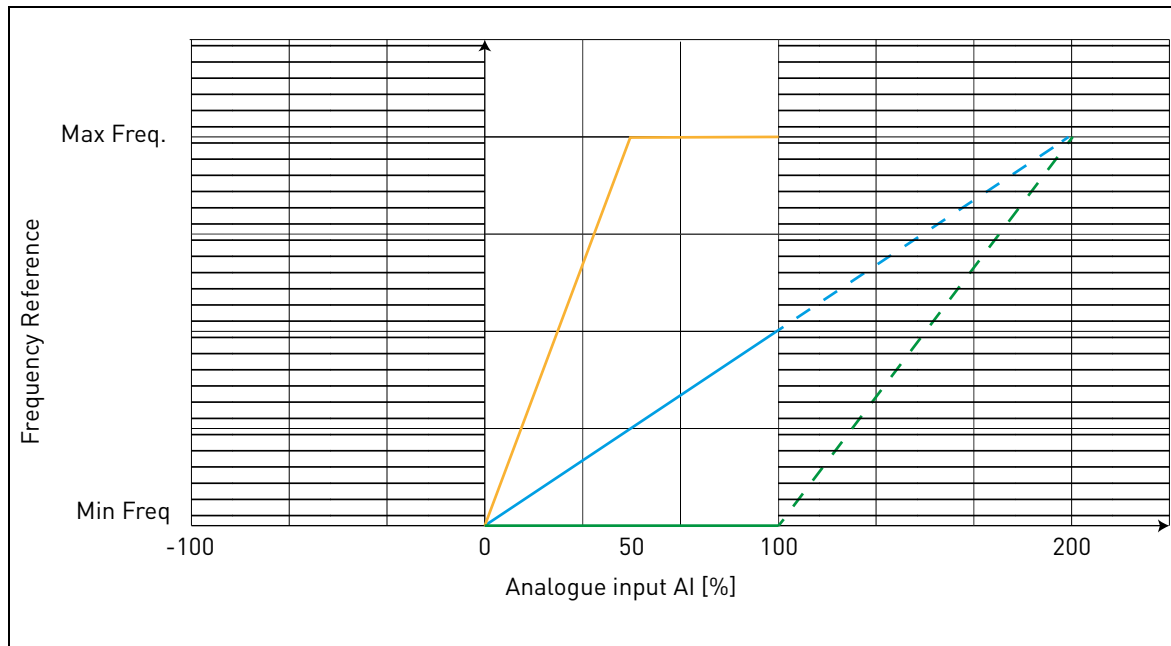

Figure 13.

Description of the Figure 13:

Blue line shows an example with Custom Min = 0% and Custom Max = 200%. This settings provides a frequency range between Minimum frequency and $(\text{Maximum frequency} - \text{Minimum frequency})/2$. With minimum analogue signal the Frequency reference is at minimum value of the set frequency range (Minimum frequency), and with maximum analogue signal the Frequency reference is at $(\text{Maximum frequency} - \text{Minimum frequency})/2$.

Green line shows an example with Custom Min = 100% and Custom Max = 200%. This settings provides a frequency range always at Minimum frequency. The Frequency reference is at Minimum frequency within the entire analogue signal range.

Orange line shows an example with Custom min = 0% and Custom Max = 50%. This settings provides a frequency range between Minimum and Maximum frequency. The Frequency reference changes linearly within the frequency range with the analogue signal between the 0% and 50% of its range. With the analogue signal between 50% and 100% of its range, the Frequency reference is always at its maximum value (Maximum frequency).

P3.9 **EXP AI RANGE**

P3.10 **EXP AI CUSTOM MIN**

P3.11 **EXP AI CUSTOM MAX**

P3.12 **EXP AI FILTER TIME**

Parameter for OPTB4 expansion analogue input.

3.4 DIGITAL INPUTS

P4.1 START SIGNAL 1

P4.2 START SIGNAL 2

Signals for start and direction. Logic is selected with P2.1.

P4.3 REVERSE DIRECTION

Should be used when Start signal 2 has not the meaning of reverse.

P4.4 EXTERNAL FAULT, CLOSE

Fault is triggered by high digital input.

P4.5 EXTERNAL FAULT, OPEN

Fault is triggered by low digital input.

P4.6 FAULT RESET

Active on rising edge.

P4.7 RUN ENABLE

Motor stops by coasting if the signal is missing.

Note: The drive is not in Ready state when Enable is low.

P4.8 PRESET SPEED BIT0

P4.9 PRESET SPEED BIT1

P4.10 PRESET SPEED BIT2

Digital inputs for preset speed selection, with binary coding.

P4.11 RAMP TIME 2 SELECTION

Ramp 2 is selected by digital input high.

P4.12 MOTOR POTENTIOMETER UP

Digital input high causes speed increase. Motor potentiometer functionality is activated only with P1.12 = 3 or P2.15 = 3.

P4.13 MOTOR POTENTIOMETER DOWN

Digital input high causes speed reduction. Motor potentiometer functionality is activated only with P1.12 = 3 or P2.15 = 3.

P4.14 CONTROL PLACE 2

Digital input high activates control place 2 (P2.10).

P4.15 FREQUENCY REFERENCE 2

Digital input high activates frequency reference source 2 (P2.11).

P4.16 PID SETPOINT 2

Digital input high activates setpoint 2 (P8.2), when P8.1=0.

P4.17 QUICK STOP OPEN

Digital input low forces drive to stop, ramping down with the time defined in P2.25. The same function can be controlled through the control word of fieldbuses Profibus, Profinet and CANOpen (information in manuals of the specific expansion board).

The drive will exit from Quick stop state when the following conditions are fulfilled:

- stop state
- main Run command is reset
- quick stop digital input is restored (or fieldbus command is cleared).
- Alarm 63 is shown when quick stop is active.

3.5 DIGITAL OUTPUTS

P5.1 TO

P5.3 RO1, RO2 AND DO1 SIGNAL SELECTION

Function for relays and digital output.

Selection	Selection name	Description
0	Not used	
1	Ready	The frequency converter is ready to operate
2	Run	The frequency converter operates (motor is running)
3	General fault	A fault trip has occurred
4	General fault inverted	A fault trip has not occurred
5	General alarm	
6	Reversed	The reverse command has been selected
7	At speed	The output frequency has reached the set reference
8	Frequency supervision	Output frequency is over/under the limit set with parameters P5.9 and P5.10
9	Current supervision	Motor current is over the limit set with parameter P5.11
10	Analogue inputs supervision	Analogue inputs selected with parameter P5.12 is over/under the limits set in P5.13 and P5.14
11	Fieldbus bit 1	Bit from fieldbus Aux Control word
12	Fieldbus bit 2	Bit from fieldbus Aux Control word
13	External brake	The drive is running and the thresholds for brake open have been reached
14	Temperature supervision	Measured temperature is over/below limit (only with OPTBH board, see P13.2-3-5-7)

Table 20. Functions for digital relays.

P5.4 RO1 ON DELAY

P5.5 RO1 OFF DELAY

Possible delays for ON/OFF transitions.

P5.6 RO1 INVERSION

Inversion of relay state.

P5.7 RO2 ON DELAY

P5.8 RO2 OFF DELAY

Possible delays for ON/OFF transitions.

P5.9 TO**P5.11 EXPANSION RO1/E01, RO2/E02, RO3/E03 SIGNAL SELECTION**

These parameters are visible only when an expansion board with outputs is installed (to see table below). Relays are available on boards OPT-B2, B5, B9 and BF.

Digital outputs are available on board OPTB1, if less than 6 terminals are used as inputs, and on OPTBF.

		OPTB1	OPTB2	OPTB5	OPTB9	OPTBF
P5.9	R01/E01	visible if P2.24 < 4	visible	visible	visible	visible
P5.10	R02/E02	visible if P2.24 < 5	visible	visible	-	-
P5.11	R03/E03	visible if P2.24 < 6	-	visible	-	-

Table 21. Digital outputs available with OPTB boards

P5.12 EXPANSION DO1 SIGNAL SELECTION

This parameter is visible only when expansion board OPTBF is installed.

3.6 ANALOGUE OUTPUT

P6.1 ANALOGUE OUTPUT FUNCTION

Signal coupled to analogue output.

Selection	Selection name	Value corresponding to maximum output
0	Not used	output always fixed at 100%
1	Frequency reference	Max frequency(P1.2)
2	Output frequency	Max frequency(P1.2)
3	Motor speed	Motor nominal speed
4	Motor current	Motor nominal current
5	Motor torque	Motor nominal torque (absolute value)
6	Motor power	Motor nominal power (absolute value)
7	PID output	100%
8	Fieldbus control	10000

Table 22. Analogue output signals.

P6.2 ANALOGUE OUTPUT MINIMUM SIGNAL

0: 0V

1: 2V

P6.3 ANALOGUE OUTPUT SCALING

Scaling factor.

P6.4 ANALOGUE OUTPUT FILTER TIME

Time constant of low pass filter.

P6.5 EXP AO1 FUNCTION

P6.6 EXP AO1 MINIMUM SIGNAL

P6.7 EXP AO1 OUTPUT SCALING

P6.8 EXP AO1 FILTER TIME

Parameters for OPTB4-OPTBF expansion analogue output.

P6.9 EXP AO2 FUNCTION

P6.10 EXP AO2 MINIMUM SIGNAL

P6.11 EXP AO2 OUTPUT SCALING

P6.12 EXP AO2 FILTER TIME

Parameters for OPTB4 expansion analogue output 2.

3.7 SUPERVISIONS

P7.7 **EXTERNAL BRAKE OPEN FREQUENCY**

P7.8 **EXTERNAL BRAKE OPEN CURRENT**

Thresholds that must be reached for external brake open at start.

Note: if a digital output has been programmed for brake control, the frequency reference is internally limited to P7.7 + 0.1Hz until the brake is opened.

P7.9 **EXTERNAL BRAKE CLOSE FREQUENCY**

The brake is closed when the start command is low and output frequency is below this threshold. The brake is also closed whenever the drive is no more in Run state.

P7.10 **PROCESS DISPLAY SOURCE**

Monitor V1.24 can show a process value, proportional to a variable measured by the drive. Source variables are:

- 0: PID actual value (max: 100%)
- 1: output frequency (max: Fmax)
- 2: motor speed (max: Speed at Fmax)
- 3: motor torque (max: Tnom)
- 4: motor power (max: Pnom)
- 5: motor current (max: Inom)

P7.11 **PROCESS DISPLAY DECIMAL DIGITS**

Number of decimals shown on monitor V1.24 and also on parameter P7.12.

P7.12 **PROCESS DISPLAY MAX VALUE**

Value shown on V1.24 when source variable is at its maximum. Proportionality is kept if the source overtakes the maximum.

3.8 MOTOR CONTROL

P8.1 MOTOR CONTROL MODE

0: Frequency control

1: Speed control (sensorless control)

In speed control, the motor slip is compensated.

Note: motor identification automatically sets this parameter to 1.

P8.2 FIELD WEAKENING POINT

Output frequency corresponding to max voltage.

Note: if P1.7 Nominal Frequency is changed, P8.2 will be set at same value.

P8.3 FIELD WEAKENING POINT VOLTAGE

Motor voltage when frequency is above FWP, defined as % of nominal voltage.

Note: if P1.6 Nominal Voltage is changed, P8.3 will be set at 100%.

P8.4 U/F SELECTION

0: linear

The voltage of the motor changes linearly as a function of output frequency from zero frequency voltage P8.7 to the field weakening point (FWP) voltage P8.3 at FWP frequency P8.2 This default setting should be used if there is no special need for another setting.

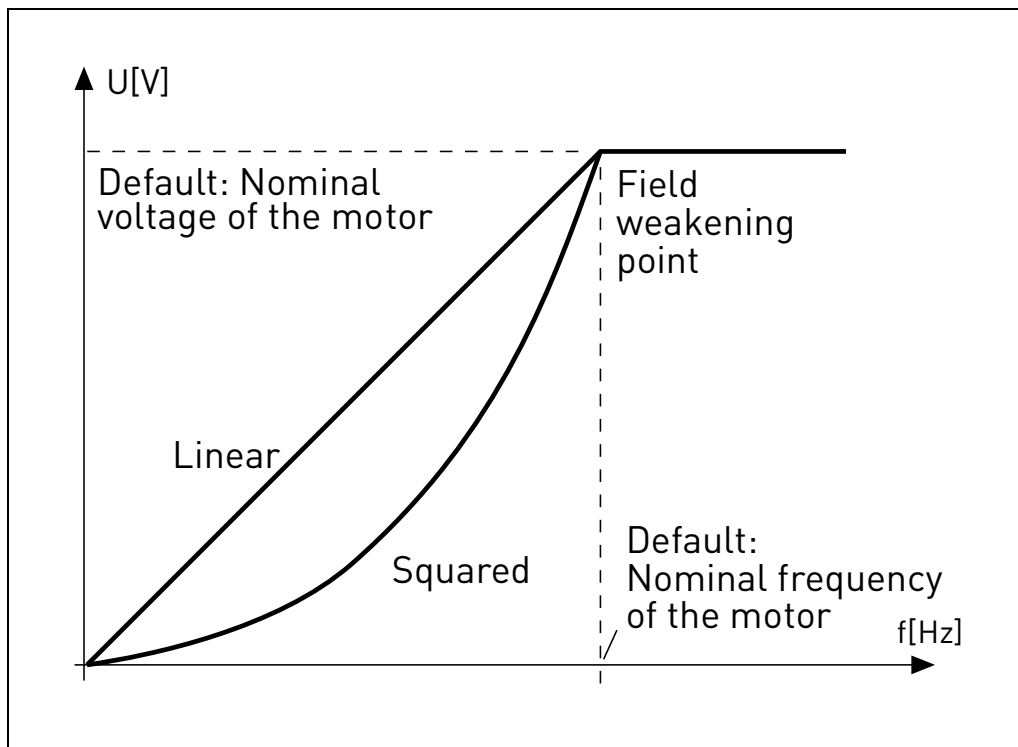

Figure 14. Linear and quadratic curve of the motor voltage.

1: quadratic

(from voltage P8.7 at 0Hz, to voltage P8.3 at P8.2 frequency)

The voltage of the motor changes from zero point voltage P8.7 following a squared curve form from zero to the field weakening point P8.3. The motor runs under-magnetized below the field weakening point and produces less torque. Squared U/f ratio can be used in applications where torque demand is proportional to the square of the speed, e.g. in centrifugal fans and pumps.

2: programmable

The U/f curve can be programmed with three different points: Zero frequency voltage (P1), Midpoint voltage/frequency (P2) and Field weakening point (P3).

Programmable U/f curve can be used if more torque is needed at low frequencies. The optimal settings can automatically be achieved with Motor identification run.

Note: motor identification automatically sets this parameter to 2.

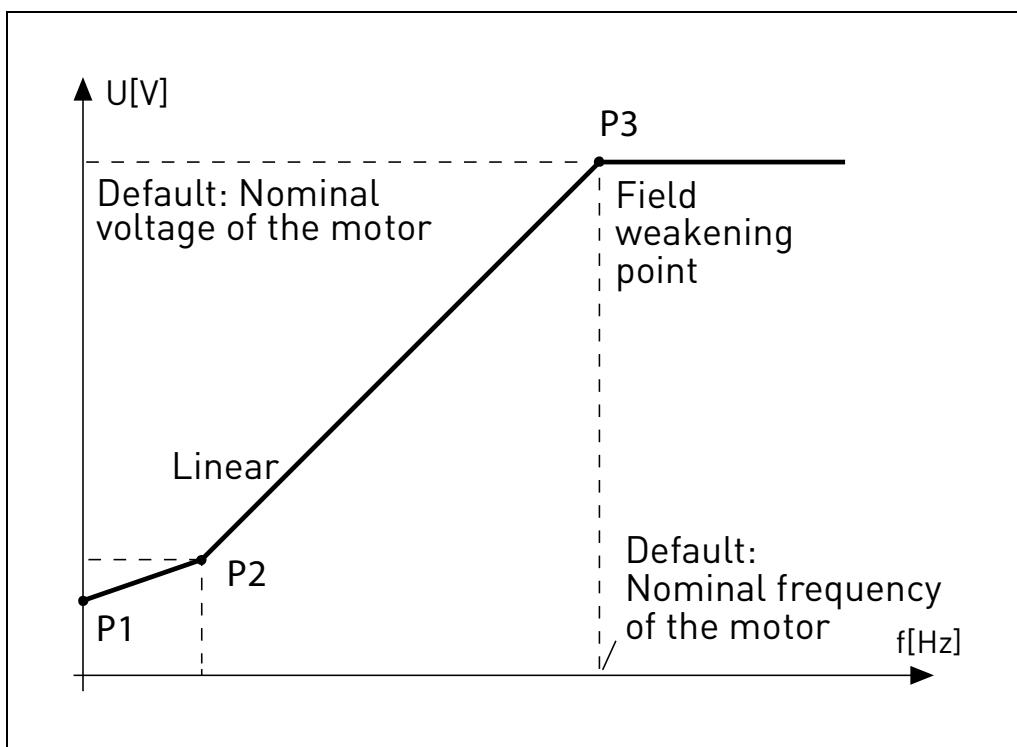

Figure 15. Programmable curve.

P8.5 **U/F MID POINT FREQUENCY**

Enabled if P8.4= 2.

Note: motor identification automatically sets this parameter.

P8.6 **U/F MID POINT VOLTAGE**

Enabled if P8.4= 2.

Note: motor identification automatically sets this parameter.

P8.7 VOLTAGE AT F0

Motor voltage at frequency zero.

Note: motor identification automatically sets this parameter.

P8.8 SWITCHING FREQUENCY

PWM frequency. Values above default can cause thermic overload of the drive.

P8.9 BRAKE CHOPPER

0 = Chopper disabled

1 = Chopper enabled in Run state

2 = Chopper enabled in Ready state

P8.10 BRAKE CHOPPER LEVEL

DC link voltage above which chopper is activated.

P8.11 DC BRAKING CURRENT

DC current injected at start or stop.

P8.12 STOP DC CURRENT TIME

Time for DC current injection at stop.

P8.13 STOP DC CURRENT FREQUENCY

DC current injection starts below this frequency.

P8.14 START DC BRAKE TIME

Time for DC current injection at start.

P8.15 RS VOLTAGE DROP

Voltage drop on stator windings, at motor nominal current, defined as % of nominal voltage. Value affects motor torque estimation, slip compensation and voltage boost.

Note: it is suggested not to program manually the value, but to perform motor identification procedure that automatically sets the value.

P8.16 MOTOR IDENTIFICATION

This procedure measures motor stator resistance and automatically sets U/f characteristic, to obtain good torque also at low speed.

0 = not active

1 = standstill identification

Run command must be given and hold high within 20s after programming the value 1. The motor does not rotate and the drive will automatically exit run state at the end of the measurements.

Note: the drive exits run state only, if the measured current exceeds 55% of the motor nominal current. Procedure sets the following parameters: P8.4, P8.5, P8.6, P8.7, P8.15.

Note: optimized U/f settings will cause motor current values comparable to nominal one, also at very low speed. External cooling of the motor is needed if the motor works in this condition for significant time.

P8.17 **OVERVOLTAGE CONTROLLER**

Overvoltage regulator automatically increases deceleration ramp time if the internal DC link voltage is too high.

0: enabled

1: disabled

P8.18 **UNDERVOLTAGE CONTROLLER**

Undervoltage regulator automatically decelerates the motor if the internal DC link voltage is too low.

0: enabled

1: disabled

P8.19 **SWITCHING FREQUENCY CONTROLLER**

Switching frequency regulator automatically decreases the PWM frequency if the unit temperature is too high.

0: enabled

1: disabled

3.9 PROTECTIONS

P9.1 ANALOGUE INPUT FAULT (AI < 4mA)

0: No action

1: Warning

2: Fault

3: Warning if Start active

4: Fault if Start active

Analogue reference below 4mA.

P9.2 ANALOGUE INPUT FAULT DELAY

Delay as filter on fault generation

P9.3 EARTH FAULT

0: No action

1: Warning

2: Fault

Output currents sum not zero.

P9.4 MOTOR STALL FAULT

0: No action

1: Warning

2: Fault

This is an overload protection. Stall is recognized by maximum motor current (=P1.5) and low output frequency.

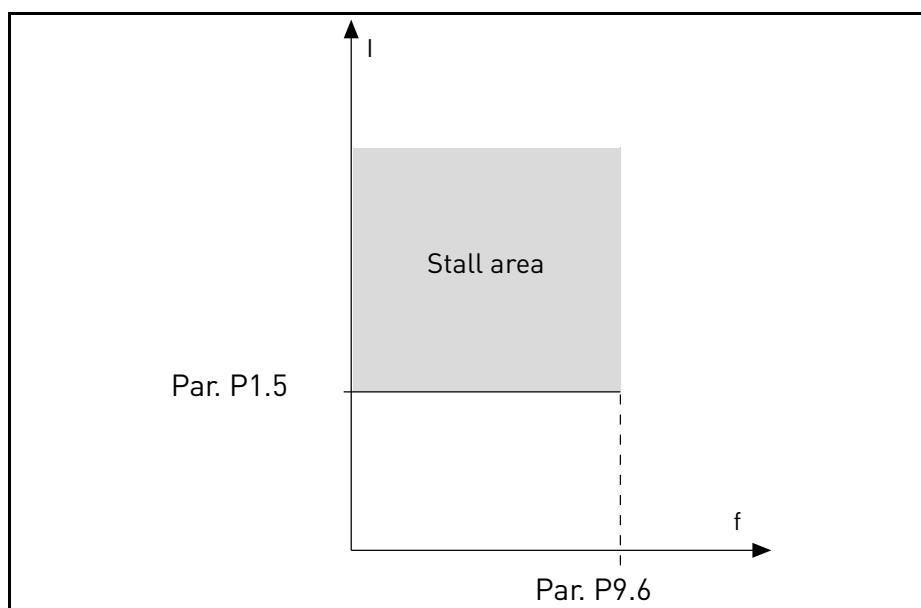

Figure 16. Stall characteristic settings.

P9.5 STALL TIME LIMIT

This time can be set between 0.0 and 300.0 s.

This is the maximum time allowed for all stage. the stall time is counted by an internal up/down counter. If the stall time counter value goes above this limit the protection will cause a trip.

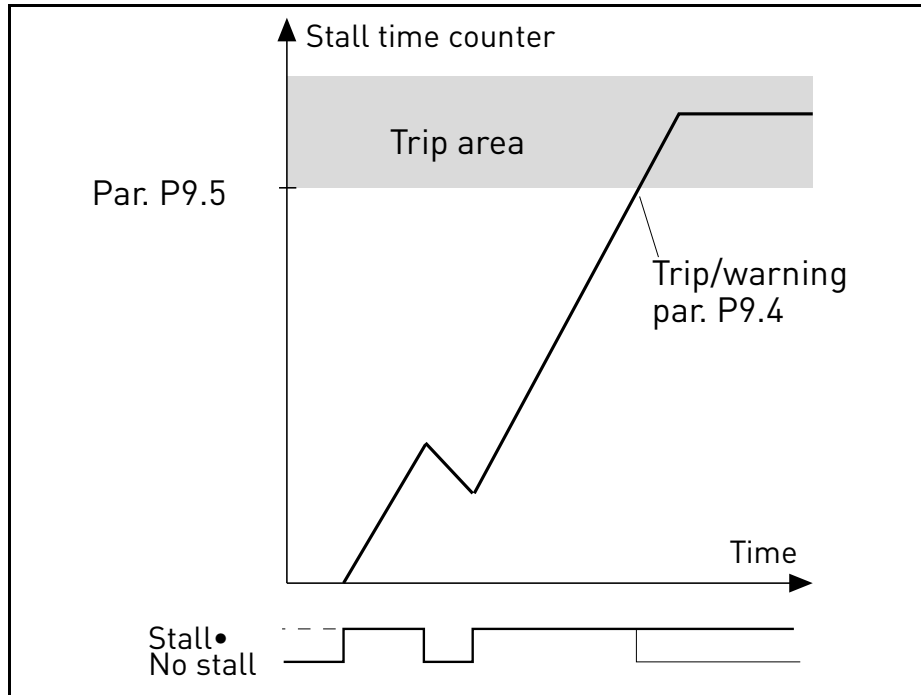

Figure 17. Stall time count.

P9.6 STALL FREQUENCY LIMIT

Stall is recognized when the current limiter has reduced the output frequency below P9.6, for the time in P9.5.

P9.7 UNDERLOAD FAULT

- 0: No action
- 1: Warning
- 2: Fault

Underload is recognized when torque is above the minimum curve defined by P9.8 and P9.9, for the programmed time P9.10.

P9.8 UNDERLOAD FAULT: FIELD WEAKENING AREA LOAD

The torque limit can be set between 10.0-150.0% x T_{nMotor} .

This parameter gives the value for the minimum torque allowed when the output frequency is above the field weakening point.

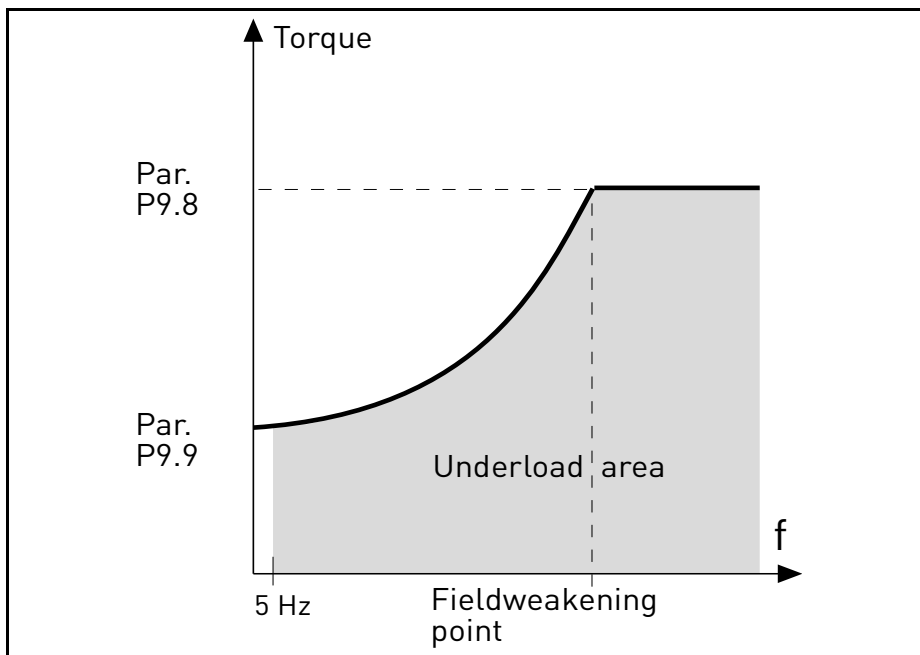

Figure 18. Underload characteristic settings.

P9.9 UNDERLOAD FAULT: ZERO FREQUENCY LOAD

P9.10 UNDERLOAD FAULT: TIME LIMIT

Definition of minimum load at nominal and zero speed zero. Fault condition delay. This time can be set between 1.0 and 300.0 s.

This is the maximum time allowed for an underload state to exist. An internal up/down counter counts the accumulated underload time. If the underload counter value goes above this limit the protection will cause a trip according to parameter P9.7). If the drive is stopped the underload counter is reset to zero.

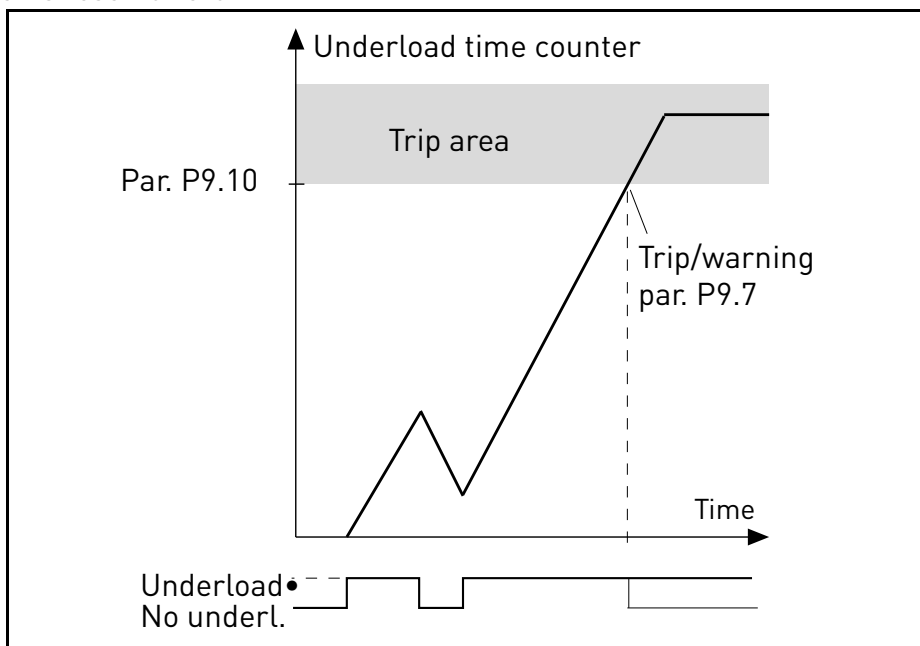

Figure 19. Underload time counter.

P9.11 MOTOR THERMAL FAULT

0: No action

1: Warning

2: Fault

This is a software protection, based on time integral of current.

P9.12 MOTOR AMBIENT TEMPERATURE FACTOR

Change if environment is not standard.

P9.13 MOTOR THERMAL ZERO SPEED COOLING

Defines the cooling factor at zero speed in relation to the point where the motor is running at nominal speed without external cooling. See Figure 20.

The default value is set assuming that there is no external fan cooling the motor. If an external fan is used this parameter can be set to 90% (or even higher).

Setting this parameter does not affect the maximum output current of the drive which is determined by parameter P1.5 alone.

The corner frequency for the thermal protection is 70% of the motor nominal frequency (P1.7).

Set 100% if the motor has independent fan or cooling. Set 30-40% if the fan is on motor shaft.

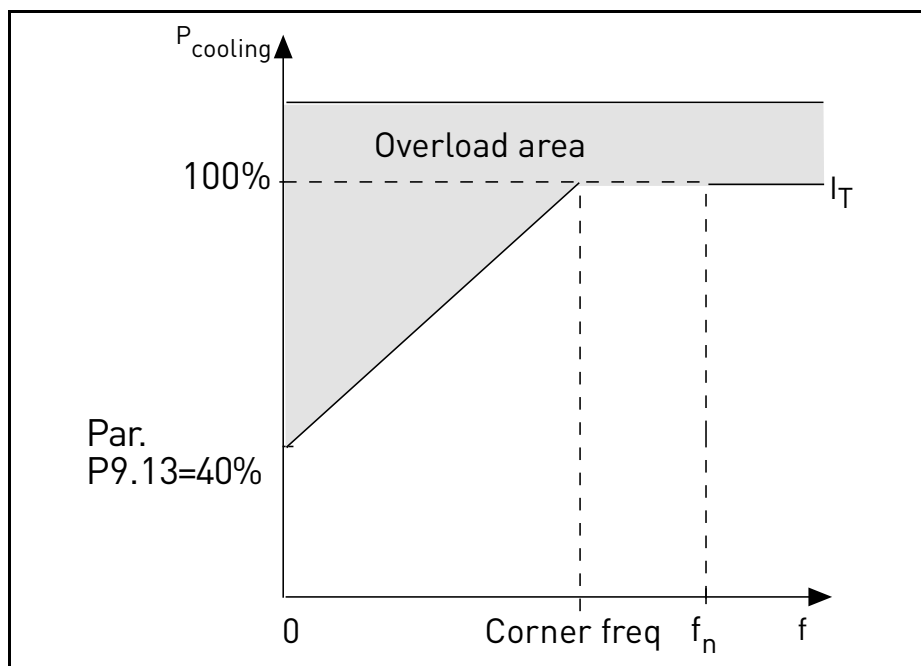

Figure 20. Motor thermal current I_T curve.

P9.14 MOTOR THERMAL TIME CONSTANT

Time at nominal current, to reach nominal temperature.

The time constant is the time within which the calculated thermal stage has reached 63% of its final value. The bigger the frame and/or slower the speed of the motor, the longer the time constant.

The motor thermal time is specific to the motor design and it varies between different motor manufacturers. The default value of the parameter varies from size to size.

If the motor's t6-time (t6 is the time in seconds the motor can safely operate at six times the rated current) is known (given by the motor manufacturer) the time constant parameter can be set basing on it. As a rule of thumb, the motor thermal time constant in minutes equals to 2*t6. If the drive is in stop stage the time constant is internally increased to three times the set parameter value. The cooling in stop stage is based on convection and the time constant is increased.

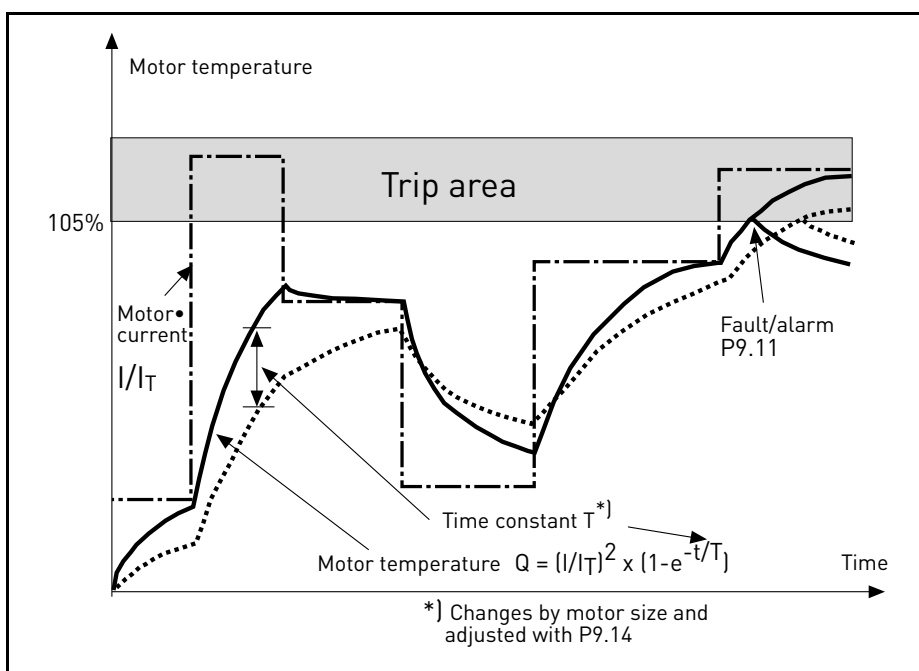

Figure 21. Motor temperature calculation.

P9.15 FIELD BUS COMMUNICATION FAULT

0: No action

1: Warning

2: Fault

Communication lost.

P9.16 THERMISTOR FAULT

0: No action

1: Warning

2: Fault

Impedance on thermistor input (optional board OPTB2) is above fault threshold.

P9.17 **PARAMETER EDIT LOCK**

0: Edit enabled

1: Edit disabled

P9.18 **RESPONSE TO SAFE TORQUE OFF**

0: No action

1: Warning

2: Fault, not stored in history

3: Fault, stored in history

Safe Torque Off disabled.

P9.19 **INPUT PHASE FAULT**

0: No action

1: Warning

2: Fault

Input phase missing.

P9.20 **INPUT PHASE FAULT RIPPLE LIMIT**

Sensitivity for input phases check

0: internal value (default)

1-75: sensitivity from maximum(1) to minimum (75)

P9.21 **MOTOR TEMPERATURE INITIALIZATION**

Setting of estimated motor temperature at power on

0: initialized at minimum value

1: initialized at constant value from P9.22

2: initialized at last previous value, with P9.22 used as factor

P9.22 **MOTOR TEMPERATURE INITIAL VALUE**

If P9.21= 1, motor temperature is initialized with this value.

If P9.21= 2, motor temperature is initialized with last previous value, multiplied by this value as % factor.

3.10 AUTOMATIC RESET

P10.1 AUTOMATIC RESET

0: Disabled

1: Enabled

The automatic reset function deletes fault state when the fault cause has been eliminated and the wait time P10.2 has elapsed. Parameter P10.4 determines the maximum number of automatic resets that can be effected during the trial time set by parameter P10.3. The time count starts from the first automatic reset. If the number of faults detected during the trial time exceeds the values of trials, the fault status becomes permanent and a reset command is needed.

P10.2 WAIT TIME

Time after which the converter attempts to restart the motor automatically after the fault has been eliminated.

P10.3 TRIAL TIME

Total time for reset attempts.

P10.4 NUMBER OF TRIALS

Trials attempted during time P10.3.

P10.5 RESTART FUNCTION

Start function after an automatic fault reset.

0: Start with ramp

1: Flying start

2: As defined in P1.13

3.1.1 **FIELDBUS**

P11.1 **TO**

P11.8 **FIELDBUS DATA OUT 1 - 8 SEL**

Parameter couples read only variables to output process data 1.

0: output frequency

1: motor speed

2: motor current

3: motor voltage

4: motor torque

5: motor power

6: DC link voltage

7: active fault code

8: analogue AI1

9: analogue AI2

10: digital inputs state

11: PID actual value

12: PID setpoint

13: analogue AI3 (OPTB4 needed)

14: temperature sensor 1 (OPTBH needed)

15: temperature sensor 2 (OPTBH needed)

16: temperature sensor 3 (OPTBH needed)

P11.9 **AUX CW DATA IN SEL**

Parameter defines the input process data coupled to Aux Control Word.

0: not used

1: PDI1

2: PDI2

3: PDI3

4: PDI4

5: PDI5

P11.10 **PID SETPOINT DATA IN SEL**

Parameter defines the input process data coupled to PID setpoint. Selections as P11.9.

P11.11 **PID FEEDBACK DATA IN SEL**

Parameter defines the input process data coupled to PID actual value. Selections as P11.9.

P11.12 ANALOGUE OUT CTRL DATA IN SEL

Parameter defines the input process data coupled to analogue output control. Selections as P11.9.

3.11.1 FIELDBUS MAPPING**3.11.1.1 Fieldbus Data IN: Master -> Slave**

Modbus register	Name	Description	Range
2001	Control word(*)	Drive control	Binary coded: b0: Run b1: Reverse b2: Fault Reset(on edge)
2002	General control word	Not used	
2003	Speed reference(*)	Reference	0...10000 as 0,00...100,00% of Min freq. - Max freq. range
2004	Fieldbus Data IN 1	Programmable	0...10000
2005	Fieldbus Data IN 2	Programmable	0...10000
2006	Fieldbus Data IN 3	Programmable	0...10000
2007	Fieldbus Data IN 4	Programmable	0...10000
2008	Fieldbus Data IN 5	Programmable	0...10000
2009	Fieldbus Data IN 6	Not used	-
2010	Fieldbus Data IN 7	Not used	-
2011	Fieldbus Data IN 8	Not used	-

Table 23. (*) Modbus Data inputs. They can vary depending on fieldbus used(See specific fieldbus option board installation manual).

Notes:

- CW b0 Run is acquired on edge, only if the drive is in Ready state (see Status Word b0) and actual control place is Fieldbus.
- CW b2 Fault Reset is active even if control place is not the Fieldbus.
- Fieldbus different from Modbus have their own Control Word (see manual of the specific fieldbus board).

Fieldbus data input mapping

Fieldbus Data inputs from 1 to 5 can be configured, with parameters P11.9 - P11.12, as:

Process Data IN	Description	Note
Aux Control Word	b0: enable b1: acc/dec ramp 2 selection b2: freq reference 2 selection b3: digital output 1 control b4: digital output 2 control	<ul style="list-style-type: none"> • b0 Enable is considered only when control place is the Fieldbus. It is computed in AND with a possible enable from digital input. Fall of enable will cause coasting stop. • b2 FreqRef2 Sel is considered only when control place is the Fieldbus. • functions related to bit1, b3 and b4 are available also when control place is not the Fieldbus. Aux CW must anyway be mapped onto a PDI, by means of parameter P11.9.
PID Setpoint	active if P12.1 = 3, range 0 - 10000 as 0 - 100,00% of regulation.	
PID Actual value	active if P12.4 = 2, range 0 - 10000 as 0 - 100,00% of regulation.	
Analogue Out Cntrl	active if P5.1 = 8, range 0 - 10000 as 0 - 100,00% of output.	

Table 24.

3.11.1.2 *Fieldbus Data OUT: Slave ->Master*

Modbus register	Name	Description	Range
2101	Status word(*)	Drive state	Binary coded: b0: Ready b1: Run b2: Reverse b3: Fault b4: Warning b5: Freq. reference reached b6: Zero speed
2102	General Status word	Drive state	As Status word and: b7: Control place is fieldbus
2103	Actual speed(*)	Actual speed	0...10000 as 0,00...100,00% of Min freq. - Max freq. range
2104	Fieldbus Data OUT 1	Programmable	See P11.1
2105	Fieldbus Data OUT 2	Programmable	See P11.2
2106	Fieldbus Data OUT 3	Programmable	See P11.3
2107	Fieldbus Data OUT 4	Programmable	See P11.4
2108	Fieldbus Data OUT 5	Programmable	See P11.5
2109	Fieldbus Data OUT 6	Programmable	See P11.6
2110	Fieldbus Data OUT 7	Programmable	See P11.7
2111	Fieldbus Data OUT 8	Programmable	See P11.8

Table 25. () Modbus data outputs. They can vary depending on fieldbus used(See specific fieldbus option board installation manual).*

Notes:

- Fieldbus different from Modbus have their own Status Word (see manual of the specific fieldbus board).

3.12 PID-CONTROLLER

Parameters of this group are hidden unless the regulator is used as frequency reference (P1.12= or P2.15=2)

P12.1 SETPOINT SOURCE SELECTION

0: fixed setpoint 1-2

1: analogue AI1

2: analogue AI2

3: fieldbus

P12.2 FIXED SETPOINT 1

P12.3 FIXED SETPOINT 2

Programmable setpoints. Setpoint 2 is activated with digital input defined in P4.16.

P12.4 FEEDBACK SOURCE SELECTION

0: analogue AI2

1: analogue AI1

2: fieldbus

3: AI2-AI1 (differential)

4: temperature (only with board OPTBH, see P13.8-10)

P12.5 FEEDBACK VALUE MIN

P12.6 FEEDBACK VALUE MAX

Minimum and maximum feedback values, corresponding to minimum and maximum of the signal.

P12.7 PID GAIN

Proportional gain. If set to 100%, a variation of 10% on error causes a variation of 10% on regulator output.

P12.8 PID INTEGRATION TIME

Integral time constant. If set to 1s, a variation of 10% on error will cause a variation of 10% on regulator output after 1s.

P12.9 PID DERIVATION TIME

Derivative time. If set to 1s, a variation of 10% in 1s on error causes a variation of 10% on regulator output.

P12.10 REGULATION INVERSION

0: direct control. Frequency increases if setpoint > feedback

1: inverted control. Frequency increases if setpoint < feedback

P12.11 PID MAX ERROR

If lower than 100%, determines a limit on max error. Useful to avoid excessive reaction at motor startup.

P12.12 SLEEP FREQUENCY LIMIT

This function will put the drive into sleep mode if the setpoint is reached and the output frequency stays below the sleep limit for a longer time than that set with the Sleep Delay (P12.13). This means that the start command remains on, but the run request is turned off. When the PID error value goes below, or above, the wake-up level depending on the set acting mode (P12.10) the drive will activate the run request again if the start command is still on.

P12.13 SLEEP DELAY

Time of working at minimum frequency, before entering sleep condition.

P12.14 WAKE UP LEVEL

The drive exits from sleep if the error exceeds this value. Direction of regulation (P12.10) is internally considered.

P12.15 SLEEP SETPOINT BOOST**P12.16 SLEEP BOOST TIME****P12.17 SLEEP MAX LOSS****P12.18 SLEEP LOSS CHECK TIME**

These parameters manage a more complex sleep sequence. After the time in P12.13, the setpoint is increased of the term in P12.15, for the time in P12.16. This will cause an higher output frequency. Frequency reference is then forced at minimum frequency and the feedback value is sampled.

If the variation on actual value stays then lower than P12.17 for the time in P12.18, the drive will enter sleep condition.

If this sequence is not needed, program P12.15=0%, P12.16=0s, P12.17=50%, P12.18=1s.

3.13 TEMPERATURE MEASUREMENT

Parameters of this group are hidden if option board OPTBH is not installed

P13.1 **TEMPERATURE UNIT**

0: °C

1: K

P13.2 **SUPERVISION/FAULT SENSOR SELECTION**

Temperature sensor(s) used for supervision and fault activation.

0: T1

1: T2

2: T1 +T2

3: T3

4: T3 +T1

5: T3 +T2

6: T3 +T2 +T1

P13.3 **SUPERVISION MODE**

A digital/relay output can be activated

0: not used

1: over limit (max temperature if more sensors)

1: below limit (min temperature if more sensors)

P13.4 **FAULT MODE**

A fault state can be activated

0: not used

1: over limit (max temperature if more sensors)

1: below limit (min temperature if more sensors)

P13.5 **SUPERVISION LEVEL**

Threshold for supervision activation.

P13.6 **FAULT LEVEL**

Threshold for fault F56 activation.

P13.7 **SUPERV/FAULT HYSTERESIS**

Temperature must change of this value to restore supervision/fault state.

P13.8 REFERENCE/ACTUAL SENSOR SELECTION

Temperature sensor(s) used for direct reference control or as PID actual value.

0: T1

1: T2

2: T3

3: max (T1, T2)

4: min (T1, T2)

5: max (T1, T2, T3)

6: min (T1, T2, T3)

P13.9 MIN REFERENCE/ACTUAL TEMPERATURE

Temperature corresponding to minimum reference/actual.

P13.10 MAX REFERENCE/ACTUAL TEMPERATURE

Temperature corresponding to maximum reference/actual.

4. FAULT TRACING

Fault code	Fault name	Possible cause	Remedy
1	Overcurrent	AC drive has detected too high a current ($>4 \cdot I_H$) in the motor cable: <ul style="list-style-type: none"> sudden heavy load increase short circuit in motor cables unsuitable motor 	Check loading. Check motor. Check cables and connections. Make identification run. Check ramp times.
2	Overvoltage	The DC-link voltage has exceeded the limits defined. <ul style="list-style-type: none"> too short a deceleration time brake chopper is disabled high overvoltage spikes in supply Start/Stop sequence too fast 	Make deceleration time longer. Use brake chopper or brake resistor (available as options). Activate overvoltage controller. Check input voltage.
3	Earth fault	Current measurement has detected that the sum of motor phase current is not zero. <ul style="list-style-type: none"> insulation failure in cables or motor 	Check motor cables and motor.
8	System fault	Component fault Malfunction	Reset the fault and restart. Should the fault re-occur, contact the distributor near to you.
9	Undervoltage	DC-link voltage is under the voltage limits defined. <ul style="list-style-type: none"> most probable cause: too low a supply voltage AC drive internal fault defect input fuse external charge switch not closed <p>NOTE! This fault is activated only if the drive is in Run state.</p>	In case of temporary supply voltage break reset the fault and restart the AC drive. Check the supply voltage. If it is adequate, an internal failure has occurred. Contact the distributor near to you.
10	Input phase	Input line phase is missing.	Check supply voltage, fuses and cable.
13	AC drive under-temperature	Too low temperature measured in power unit's heatsink or board. Heatsink temperature is under -10°C .	Check the ambient temperature.
14	AC drive over-temperature	Too high temperature measured in power unit's heatsink or board. Heatsink temperature is over 100°C .	Check the correct amount and flow of cooling air. Check the heatsink for dust. Check the ambient temperature. Make sure that the switching frequency is not too high in relation to ambient temperature and motor load.
15	Motor stalled	Motor is stalled.	Check motor and load.

Table 26. Fault codes and descriptions.

Fault code	Fault name	Possible cause	Remedy
16	Motor overtemperature	Motor is overloaded.	Decrease motor load. If no motor overload exists, check the temperature model parameters.
17	Motor Underload	Motor is under loaded	Check load.
19	Power overload	Supervision for drive power	Drive power is to high: decrease load.
25	Watchdog	Error in the microprocessor monitoring Malfunction Component fault	Reset the fault and restart. If the fault occurs again, please contact your closest Vacon representative.
27	Back EMF	Protection of unit when starting with rotating motor	Reset the fault and restart. Should the fault re-occur, contact the distributor near to you.
30	STO fault	Safe torque off signal does not allow drive to be set as ready	Reset the fault and restart. Should the fault re-occur, contact the distributor near to you.
35	Application error	The application is not working	Please contact your closest Vacon representative.
41	IGBT temp	IGBT temperature (UnitTemperature + I2T) too high	Check loading. Check motor size. Make identification run.
50	4 mA fault (Analog input)	Selected signal range: 4...20 mA (see Application Manual) Current less than 4 mA Signal line broken detached The signal source is faulty	Check the analog input's current source and circuit.
51	External fault	Error message on digital input. The digital input was programmed as an input for external error messages. The input is active.	Check the programming and check the device indicated by the error message. Check the cabling for the respective device as well.
52	Keypad Communication fault	The connection between the control keypad and the frequency converter is broken.	Check keypad connection and keypad cable.
53	Fieldbus communication fault	The data connection between the fieldbus master and fieldbus board is broken	Check installation and fieldbus master.
54	Fieldbus Interface error	Defective option board or slot	Check board and slot.
55	Wrong run command	Wrong run alarm and stop command	Run forward and backward are activated at the same time
56	Temperature	Temperature fault	Board OPTBH is installed and measured temperature is above (or below) the limit
57	Identification	Identification alarm	Motor identification has not been successfully completed

Table 26. Fault codes and descriptions.

Fault code	Fault name	Possible cause	Remedy
63	Quick Stop	Quick Stop activated	The drive has been stopped with Quick Stop digital input or Quick Stop command by fieldbus

Table 26. Fault codes and descriptions.

VACON[®]

DRIVEN BY DRIVES

Find your nearest Vacon office
on the Internet at:

www.vacon.com

Manual authoring:
documentation@vacon.com

Vacon Plc.
Runsorintie 7
65380 Vaasa
Finland

Subject to change without prior notice
© 2013 Vacon Plc.

Document ID:



Order code:



Rev. F